

Register your instrument!  
[www.eppendorf.com/myeppendorf](http://www.eppendorf.com/myeppendorf)



# Mastercycler® X50

Operating Manual

Copyright© 2021 Eppendorf SE, Germany.

All rights reserved, including graphics and images. No part of this publication may be reproduced without the prior permission of the copyright owner.

Eppendorf® and the Eppendorf Brand Design are registered trademarks of Eppendorf SE, Germany.

Mastercycler®, flexlid®, SteadySlope® and Eppendorf twin.tec® are registered trademarks of Eppendorf SE, Germany.

Registered trademarks and protected trademarks are not marked in all cases with ® or ™ in this manual.

U.S. Patents are listed on [www.eppendorf.com/ip](http://www.eppendorf.com/ip).

### **Notice**

The software of the Mastercycler X50 contains open source software. License information is available in the settings of the Mastercycler X50 software under *About this Mastercycler*.

## Table of contents

<b>1</b>	<b>Operating instructions</b>	<b>7</b>
1.1	Using this manual	7
1.2	Danger symbols and danger levels	7
1.2.1	Danger symbols	7
1.2.2	Danger levels	7
1.3	Symbols used	7
1.4	Abbreviations used	8
<b>2</b>	<b>Safety</b>	<b>9</b>
2.1	Intended use	9
2.2	User profile	9
2.3	Warnings for intended use	9
2.4	Danger symbols on the device	11
<b>3</b>	<b>Product description</b>	<b>13</b>
3.1	Product overview	13
3.1.1	Master variant	13
3.1.2	Eco variant	14
3.1.3	Ports	15
3.1.4	Status lamp	15
3.2	Delivery package	16
3.3	Features	16
3.3.1	Features of the Mastercycler X50	17
3.3.2	Consumables	17
3.3.3	Networking	17
3.3.4	Service	17
<b>4</b>	<b>Installation</b>	<b>19</b>
4.1	Selecting the location	19
4.2	Installing the device	20
4.2.1	Connecting the device to the power supply	20
4.2.2	Using the USB port	21
4.2.3	Connecting the Mastercycler X50 to a network	22
4.2.4	Connecting the eco device directly to the master device	23
4.2.5	Connecting multiple eco devices	23
4.3	Decommissioning	24
4.4	Registering the device	24
4.4.1	VisioNize onboard devices	24
<b>5</b>	<b>Operation</b>	<b>27</b>
5.1	First steps	27
5.1.1	Switching on the device	27
5.1.2	Opening the heated lid	27
5.1.3	Closing the heated lid	28
5.2	Operating the user interface	29
5.2.1	Logging in and out as a user	29
5.2.2	Home screen	30

5.3	Menu .....	31
5.3.1	Opening the menu .....	31
5.3.2	Events .....	32
5.3.3	Protocols .....	34
5.3.4	Export .....	36
5.3.5	Incubate .....	36
5.3.6	Maintenance & Qualification .....	37
<b>6</b>	<b>User administration .....</b>	<b>41</b>
6.1	The user administration concept .....	41
6.1.1	Administrator .....	41
6.1.2	User with standard rights .....	41
6.1.3	User with restricted rights .....	41
6.1.4	User rights without user administration .....	41
6.1.5	User rights .....	42
6.2	Defining settings in the user administration .....	44
6.2.1	Creating an administrator .....	44
6.2.2	Editing the user administration .....	45
6.2.3	Deactivating the user administration .....	46
6.3	Editing user accounts as administrator .....	47
6.3.1	Creating a user account .....	47
6.3.2	Editing user accounts .....	48
6.3.3	Deleting a user account .....	48
6.3.4	Resetting the password/PIN for a user account .....	49
6.4	Administrating your own user account .....	50
<b>7</b>	<b>Programming .....</b>	<b>51</b>
7.1	Overview of the Program Manager .....	51
7.1.1	Accessing the Program Manager .....	51
7.2	Creating a new folder .....	52
7.3	Administration of folders .....	53
7.4	Creating a new program .....	53
7.5	Administration of programs .....	55
7.6	General program settings .....	56
7.6.1	Header .....	56
7.6.2	Editing the general program settings .....	57
7.6.3	Setting the lid temperature .....	58
7.6.4	Selecting the block temperature control mode .....	58
7.6.5	Performing block settings .....	59
7.6.6	Selecting the program status .....	61
7.6.7	Entering a comment .....	61
7.7	Editing programs .....	62
7.7.1	Selecting the program step .....	62
7.7.2	Inserting a program step .....	63
7.7.3	Sketch mode .....	64
7.7.4	Setting gradients .....	65
7.7.5	Defining increments and decrements .....	66
7.7.6	Defining the ramp .....	67
7.7.7	Deleting a program step .....	67



<b>8</b>	<b>PCR run</b>	<b>69</b>
8.1	Loading the thermoblock	69
8.1.1	Selecting the sample tubes	69
8.1.2	Inserting the sample tubes	70
8.2	Selecting a program	71
8.2.1	Selecting a program in the Program Manager	71
8.2.2	Selecting the most recently used program	72
8.3	Starting a program	72
8.4	Pausing and resuming a program	73
8.5	Display the remaining run time for the program	74
8.6	Aborting the program	75
<b>9</b>	<b>Settings</b>	<b>77</b>
9.1	Accessing settings	77
9.2	About this Mastercycler	77
9.3	System Settings	77
9.3.1	Accessing System Settings	77
9.3.2	Assignment	78
9.3.3	Auto Restart	78
9.3.4	Protocol Level	79
9.3.5	Date & Time	79
9.3.6	Network	80
9.4	Device Settings	81
9.4.1	Accessing Device Settings	81
9.4.2	Acoustic Signals	81
9.4.3	Display Settings	82
9.5	Setting service and maintenance intervals	83
9.5.1	Accessing Maintenance & Qualification	83
9.5.2	Editing recurring tasks	83
<b>10</b>	<b>Maintenance</b>	<b>85</b>
10.1	Performing a software update	85
10.2	Cleaning	86
10.2.1	Cleaning the touch screen	86
10.2.2	Cleaning the housing	87
10.2.3	Cleaning the heated lid and thermoblock	88
10.3	Disinfection/decontamination	89
10.4	Decontamination before shipment	89
<b>11</b>	<b>Troubleshooting</b>	<b>91</b>
11.1	General errors	91
<b>12</b>	<b>Transport, storage and disposal</b>	<b>93</b>
12.1	Packing	93
12.2	Transport	93
12.3	Disposal	94

<b>13</b>	<b>Technical data</b> .....	<b>95</b>
13.1	Power supply .....	95
13.2	Weight/dimensions .....	95
13.3	Ambient conditions .....	95
13.4	Application parameters .....	96
	<b>Certificates</b> .....	<b>99</b>

# 1 Operating instructions









## 1.1 Using this manual

- ▶ Read this operating manual completely before using the device for the first time.
- ▶ Consider this manual as part of the product and keep it somewhere easily accessible.
- ▶ If this operating manual is lost, please request another one. The current version of the operating manual can be found on our webpage [www.eppendorf.com](http://www.eppendorf.com).

## 1.2 Danger symbols and danger levels

### 1.2.1 Danger symbols

The safety instructions in this manual have the following danger symbols and danger levels:

	<b>Biohazard</b>		<b>Explosive substances</b>
	<b>Electric shock</b>		<b>Hot surface</b>
	<b>Risk of crushing</b>		<b>Toxic substances</b>
	<b>Hazard point</b>		<b>Material damage</b>

### 1.2.2 Danger levels

<b>DANGER</b>	<i>Will</i> lead to severe injuries or death.
<b>WARNING</b>	<i>May</i> lead to severe injuries or death.
<b>CAUTION</b>	May lead to light to moderate injuries.
<b>NOTICE</b>	May lead to material damage.

## 1.3 Symbols used

Depiction	Meaning
1. 2.	Actions in the specified order
▶	Actions without a specified order
•	List
<i>Text</i>	Display or software texts
	Additional information

## 1.4 Abbreviations used

**DHCP**

Dynamic Host Configuration Protocol (network)

**DNS**

Domain Name System (network)

**IP**

Internet Protocol (network)

**MAC**

Media Access Control (network)

**PCR**

Polymerase Chain Reaction

**PDF**

Portable Document Format

**PIN**

Personal Identification Number

**USB**

Universal Serial Bus

## 2 Safety

### 2.1 Intended use

The Eppendorf Mastercycler X50 is a laboratory device for DNA amplification by means of polymerase chain reaction. The Mastercycler X50 is intended for indoor use only and may be used for training and research purposes in routine and research laboratories in the fields of life sciences, industry and chemistry. The product is intended for research purposes only and may not be used for diagnostic or therapeutic purposes.

The Mastercycler X50 uses various block types to support various consumables.

The Mastercycler X50 may only be operated by persons trained in laboratory techniques and procedures.

### 2.2 User profile

The device and accessories may only be operated by trained and skilled personnel.

Before using the device, read the operating manual and the instructions for use of the accessories carefully and familiarize yourself with the device's mode of operation.

### 2.3 Warnings for intended use

Read the operating manual and observe the following general safety instructions before using the Mastercycler X50.



**DANGER! Risk of explosion.**

- ▶ Do not operate the device in areas where work with explosive substances is carried out.
- ▶ Do not use this device to process any explosive or highly reactive substances.
- ▶ Do not use this device to process any substances which could generate an explosive atmosphere.



**WARNING! Risk of fire.**

- ▶ Do not use this device to process any highly flammable liquids.

**WARNING! Damage to health due to infectious liquids and pathogenic germs.**

- ▶ When handling infectious liquids and pathogenic germs, observe the national regulations, the biosafety level of your laboratory, and the manufacturers' Safety Data Sheets and application notes.
- ▶ Wear your personal protective equipment.
- ▶ For comprehensive regulations about handling germs or biological material of risk group II or higher, please refer to the "Laboratory Biosafety Manual" (source: World Health Organization, Laboratory Biosafety Manual, in the currently valid version).

**WARNING! Lethal voltages inside the device.**

Touching high-voltage parts can cause an electric shock. Electric shocks cause heart injury and respiratory paralysis.

- ▶ Ensure that the housing is closed and undamaged.
  - ▶ Do not remove the housing.
  - ▶ Ensure that no liquids can penetrate the device.
- Only authorized service staff may open the device.

**WARNING! Biohazard when tempering with the heated lid open.**

When tempering with an open heated lid, the lids of the reaction vessels can spring open. This will release sample material.

- ▶ Only temper with a closed heated lid.

**WARNING! Biohazard due to unsuitable reaction vessels, plates and lids.**

Unsuitable reaction vessels, plates and lids will get damaged in the Cyclor. This will release sample material.

- ▶ Only use reaction vessels, plates and lids that meet the requirements specified in the operating manual.

**CAUTION! Risk of burns on the thermoblock, heated lid and reaction vessels.**

The thermoblock, heated lid and reaction vessels reach temperatures of over 50 °C very quickly.

- ▶ Wait until the temperature of the thermoblock, heated lid and reaction vessels is below 30 °C.
- ▶ Then open the heated lid.

**CAUTION! Risk of poor safety due to incorrect accessories and spare parts.**

The use of accessories and spare parts other than those recommended by Eppendorf may impair the safety, functioning and precision of the device. Eppendorf cannot be held liable or accept any liability for damage resulting from the use of accessories and spare parts other than those recommended or from improper use.

- ▶ Only use accessories and original spare parts recommended by Eppendorf.



**WARNING! Risk of injury when lifting the device.**

If the device is lifted by its lid, the lid may break off and cause the device to fall.

- ▶ Lift the device by the bottom of the housing.
- ▶ Use both hands to carry the device.
- ▶ Do not lift the device by its lid.



**CAUTION! Risk of injury due to lifting and carrying heavy loads**

The device is heavy. Lifting and carrying the device can lead to back injuries.

- ▶ Only transport and lift the device with an adequate number of helpers.
- ▶ Use a transport aid to transport the device.



**NOTICE! Damage to electronic components due to condensation.**

Condensate may form in the device after it has been moved from a cool environment to a warmer environment.

- ▶ After installing the device, wait for at least 12 h. Only then connect the device to the mains/power line.

## 2.4 Danger symbols on the device

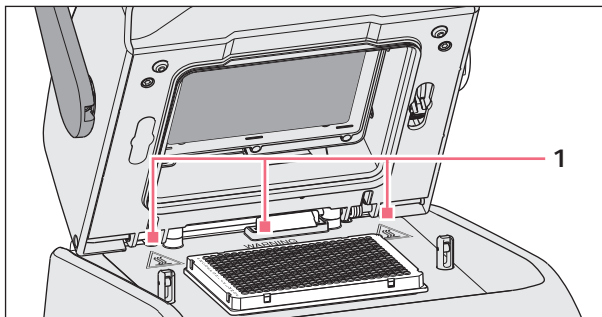

Fig. 2-1: Warning symbols on the Mastercycler

1



**Burns due to hot surfaces.**

If the heated lid is open, you may suffer burns when touching the thermoblock and the hot plate.

- ▶ Do not touch any hot surfaces.





**3 Product description**  
**3.1 Product overview**  
**3.1.1 Master variant**

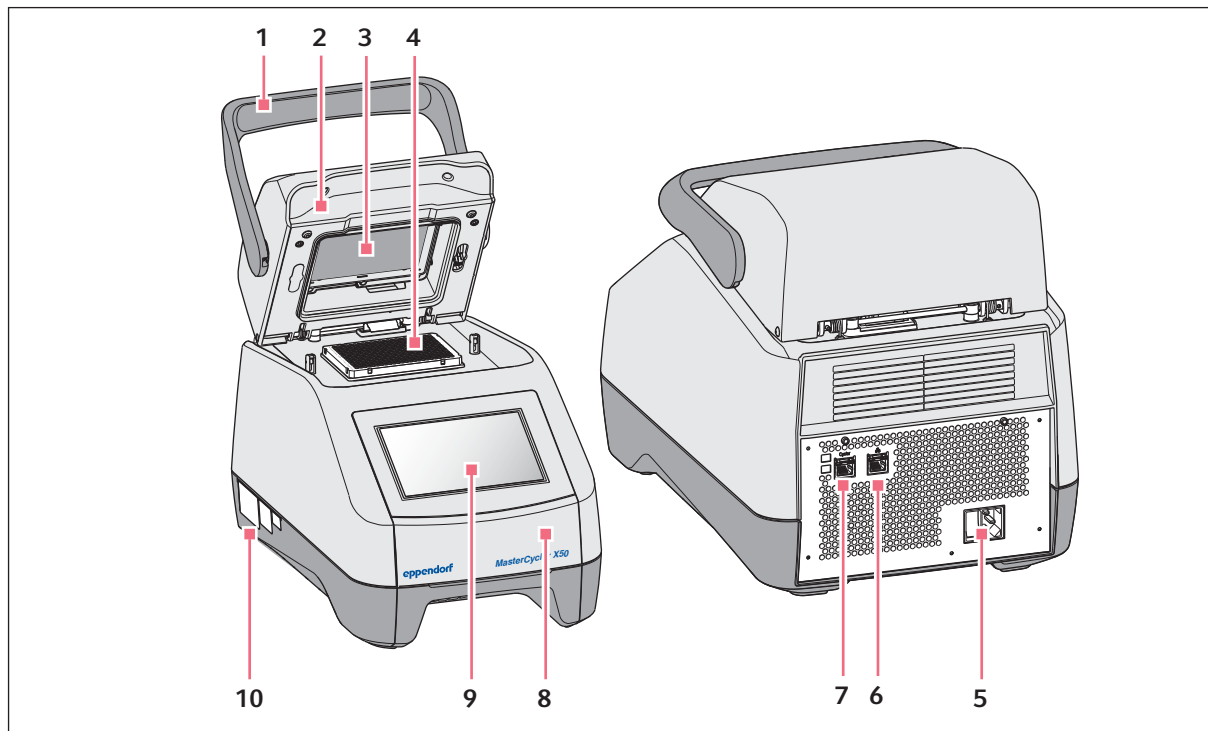

Fig. 3-1: Front view and rear view

- |  |                                 |
|--|---------------------------------|
| <b>1 Lid handle</b><br>For opening and closing the heated lid.                                 | <b>6 Ethernet port</b>          |
| <b>2 Heated lid</b>  | <b>7 Cyclor port</b>            |
| <b>3 Heating plate</b>   | <b>8 Lid</b><br>USB port cover. |
| <b>4 Thermoblock</b>   | <b>9 Touch screen</b>           |
| <b>5 Mains/power cord socket with mains/power switch</b><br>0 = switched off, I = switched on. | <b>10 Name plate</b>            |

### 3.1.2 Eco variant

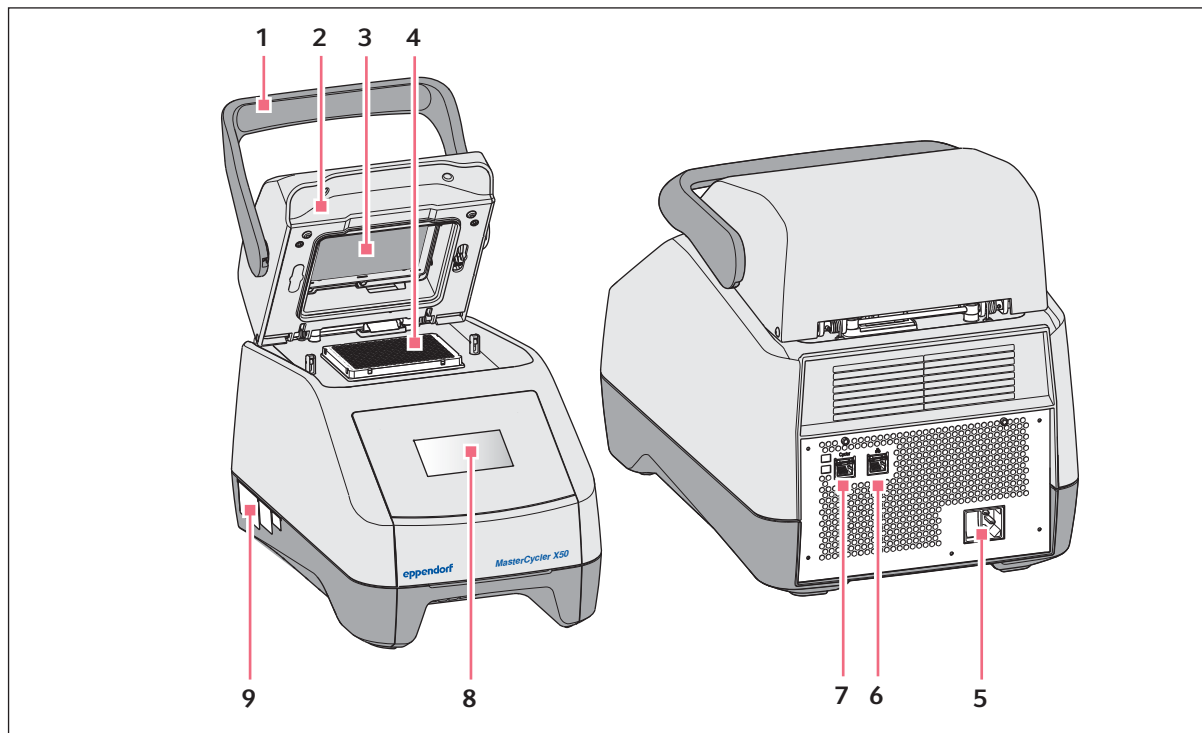

Fig. 3-2: Front view and rear view

- |  |  |
|--|--|
| <p><b>1 Lid handle</b><br/>For opening and closing the heated lid.</p> <p><b>2 Heated lid</b></p> <p><b>3 Heating plate</b></p> <p><b>4 Thermoblock</b></p> <p><b>5 Mains/power cord socket with mains/power switch</b><br/>0 = switched off, I = switched on.</p> | <p><b>6 Deactivated port</b></p> <p><b>7 Cyclor port</b></p> <p><b>8 Display</b><br/>Information is displayed. Operation is not possible.</p> <p><b>9 Name plate</b></p> |
|--|--|

### 3.1.3 Ports

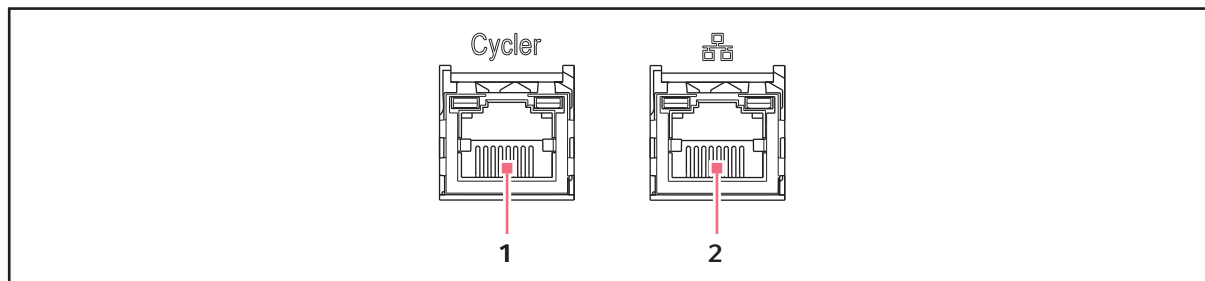

Fig. 3-3: Ports

#### 1 Cyclor port

Connection to an eco variant of the Mastercycler X50 or an Ethernet switch.

#### 2 Ethernet port

Connection to the Internet for master variants. In eco devices this port is deactivated.

Only Mastercycler X50 eco devices can be connected to a Mastercycler X50 master device.

### 3.1.4 Status lamp

The status lamp is located on the right above the touch screen.

Status lamp	Operating status
Lights up yellow	The device is starting up.
Briefly flashes yellow, then lights up white	The device is in idle mode.
Flashes blue	A program run is active.
Flashes green	A program run is completed.
Flashes yellow	The program run is waiting for a user action in the Pause or Hold step.
	During a program run the lid is open.
Lights up blue	The heating block is active. No program is selected.
	The heated lid is active. No program is selected.
	Verification of the thermoblock.
Lights up violet	After a mains/power outage the device will be automatically restarted.
Flashes red	Device error. See the display for additional information on the type of error.
Flashes violet	Software update

### 3.2 Delivery package

Quantity	Description
1	Mastercycler X50 in the ordered version
1	Operating manual for all master variants. Eco devices are delivered without an operating manual.
1	Certificate of uniformity
1	Mains/power cord with EU-plug
1	Mains/power cord with US-plug
1	1.5 m Ethernet cable



The Ethernet switch is not included in the delivery package and it is not available from Eppendorf.

### 3.3 Features

**Circuit Technology:** Circuit Technology ensures a homogeneous temperature distribution and enables the generation of specific temperature gradients for PCR optimizations on the Mastercycler X50.

**SteadySlope:** The SteadySlope technology ensures that the heating and cooling rates of the thermoblock during gradient operation are identical to those during normal operation. The reliable transfer of optimization results to the routine application is ensured.

**Program Migration:** Program Migration enables the transfer of a PCR program from other thermal cyclers with a lower temperature control speed to a Mastercycler X50. The required run time is entered into the Mastercycler X50 (see *Performing block settings on p. 59*) and the device calculates the matching ramps automatically. This function enables a simulation of the PCR run without performing PCR optimization first.

**flexlid:** Except for the versions with a High Pressure Lid, all Mastercycler X50 are equipped with a flexlid heated lid. It enables an ergonomic one-hand operation and automatically adjusts the contact pressure for all tubes and PCR plates.

**Thermal Sample Protection:** The Thermal Sample Protection technology maintains a constant thermoblock temperature of 20 °C during the warm-up phase of the heated lid. Thermal Sample Protection reduces the thermal load on the samples and minimizes the risk of non-specific product formation during the PCR.

**Self test function:** The master variants of the Mastercycler X50 have an integrated self test function. The self test function provides a simple way of testing the correct function of the thermoblock of the master device and the connected eco devices without any auxiliary equipment.

**Control:** The eco variants of the Mastercycler X50 do not have a control panel. They are controlled via a connected master variant of the Mastercycler X50.

### 3.3.1 Features of the Mastercycler X50

	Master device	Thermoblock version	Thermoblock material	High Pressure Lid
Mastercycler X50a	X	96-well format	Aluminum	—
Mastercycler X50h	X	384-well format	Aluminum	X
Mastercycler X50l	—	96-well format	Aluminum	—
Mastercycler X50t	—	384-well format	Aluminum	X
Mastercycler X50s	X	96-well format	Silver	—
Mastercycler X50i	—	96-well format	Silver	—

### 3.3.2 Consumables

	PCR strips (0.1 mL) or PCR tubes (0.2 mL)	PCR plates
Mastercycler X50a	96	1x 96-well
Mastercycler X50h	—	1x 384-well
Mastercycler X50l	96	1x 96-well
Mastercycler X50t	—	1x 384-well
Mastercycler X50s	96	1x 96-well
Mastercycler X50i	96	1x 96-well

### 3.3.3 Networking

An additional eco device of the Mastercycler X50 can be directly connected to and controlled by a master device of the Mastercycler X50.

An Ethernet switch can be used to connect and control up to 9 eco devices of the Mastercycler X50.

### 3.3.4 Service

Eppendorf offers customized service options for preventive maintenance and verification of your thermal cycler. For more information, service requests and local offers visit [www.eppendorf.com/epServices](http://www.eppendorf.com/epServices) and the local websites.



## 4 Installation

### 4.1 Selecting the location

---



**WARNING! Risk of injury due to unsuitable work surface.**

The device may fall down if placed on an unsuitable work surface.

- ▶ Observe the criteria for selecting a location. The criteria can be found in the operating manual.
- 



**NOTICE! Risk of damage due to overheating.**

- ▶ Do not install the device near heat sources (e.g., heating, drying cabinets).
  - ▶ Do not expose the device to direct sunlight.
  - ▶ Ensure unobstructed air circulation. Maintain a clearance of at least 30 cm around all ventilation gaps.
- 



When the device is in operation, ensure that the device mains/power switch and the cutting unit of the power system circuit (e.g., residual current circuit breaker) are accessible.

Take the following criteria into account when selecting the location for the device:

- Do not place the device in a wet location.
- The surface must have sufficient bearing capacity and ensure the required stability.
- The surface must be free of vibration.
- The device feet must not slip.
- The height of the location should allow for convenient and safe operation of the device.

## 4.2 Installing the device

### 4.2.1 Connecting the device to the power supply

---



**WARNING! Danger due to incorrect voltage supply.**

- ▶ Only connect the device to voltage sources which correspond with the electrical requirements on the name plate.
  - ▶ Only use earth/grounded sockets with a protective earth (PE) conductor.
  - ▶ Only use the mains/power cord supplied.
- 



**NOTICE! Sample loss through interruption in the mains/power supply.**

If you use multiple sockets, the current consumption of several devices may exceed the power current strength. The mains/power fuse interrupts the mains/power supply. The devices do not receive any power. The current programs are aborted.

- ▶ Connect the mains/power cord of each device directly to an earth/grounded socket.
  - ▶ Do not use multiple sockets.
- 



**NOTICE! Impairment to the display caused by the protective foil**

The display functionality can be impaired if the protective foil is peeled off when the device is switched on.

- ▶ Remove the protective foil before switching on the device for the first time.
- 

- ▶ Connect the mains connection socket to the power socket using a power cable.



#### 4.2.2 Using the USB port

The master variants of the Mastercycler X50 have a USB port to which a storage medium can be connected.

There is no USB port on the eco devices.

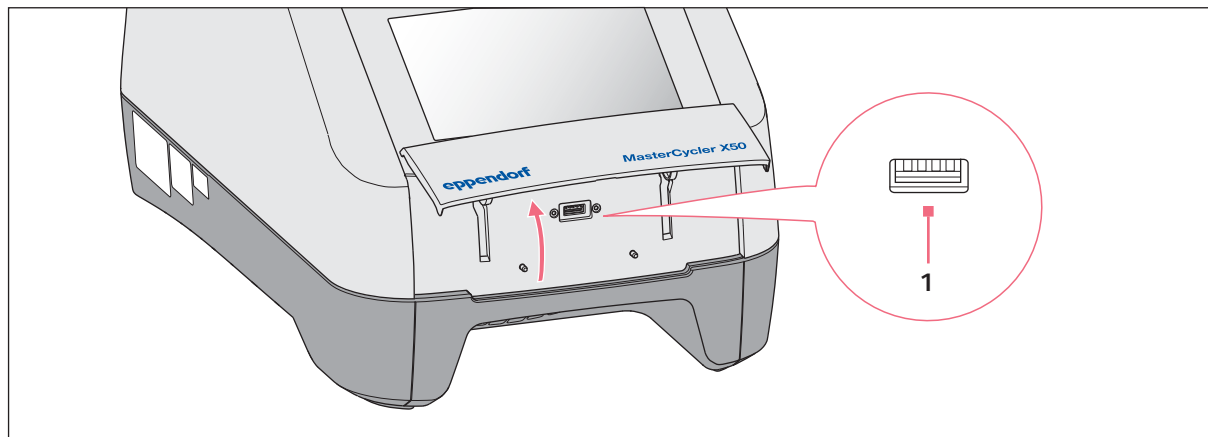

1. Open the lid.
2. Insert the storage medium into the USB port (1).
3. After data has been imported or exported: Remove the storage medium and close the lid.

### 4.2.3 Connecting the Mastercycler X50 to a network



The master device can be connected directly to the Internet and to an internal network. An Internet connection is not necessary to operate the device. If the master device is connected to the Internet the operator is responsible for data security.

- ▶ A connection to the internal network or the Internet can only be made by a network administrator.
- ▶ Check the settings for the internal network or the Internet before making a connection.



The device has a network connection (RJ45). It is possible to work with a DHCP or a fixed IP address. The connection is possible with any common, ethernet-based infrastructure. We recommend 100 Mbit or 1 Gbit connections (autonegotiation).

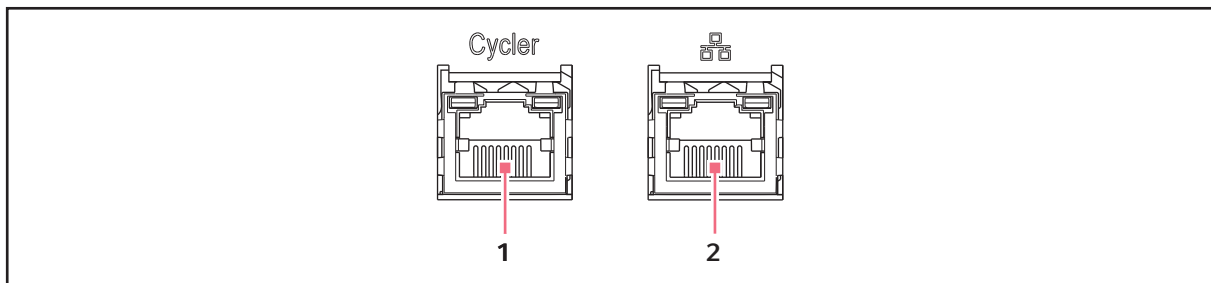

#### 1 Cycler port

#### 2 Ethernet port. In eco devices this port is deactivated.

1. Connect the master device to the internal network via the **Cycler** port.
2. Connect the eco devices to the internal network via the **Cycler** port.

The eco devices are recognized by the master device and can be assigned to the master device (see *Assignment on p. 78*).

3. Connect the master device to the Internet via port **2**.

#### 4.2.4 Connecting the eco device directly to the master device

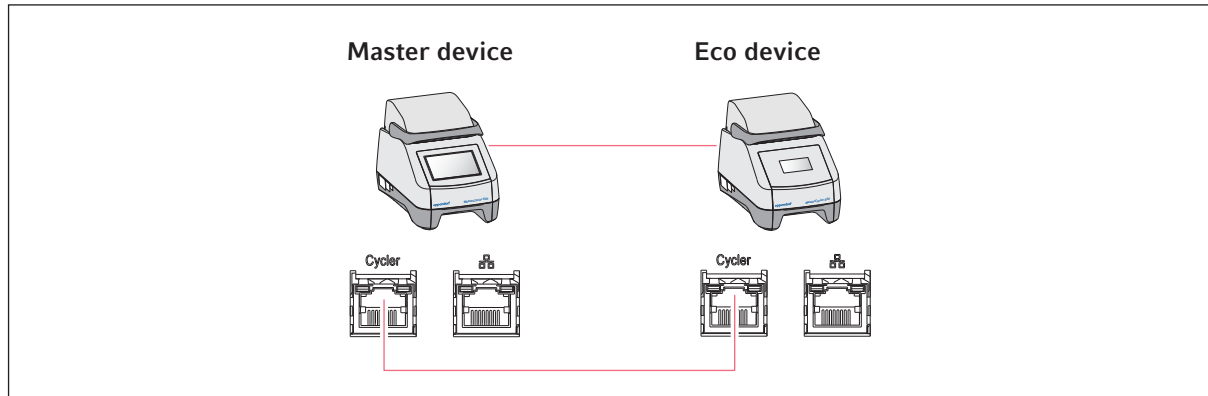

- ▶ Connect the master device and the eco device via the **Cyclor** ports.  
The eco device is recognized by the master device and can be assigned to the master device (see *Assignment on p. 78*).

#### 4.2.5 Connecting multiple eco devices

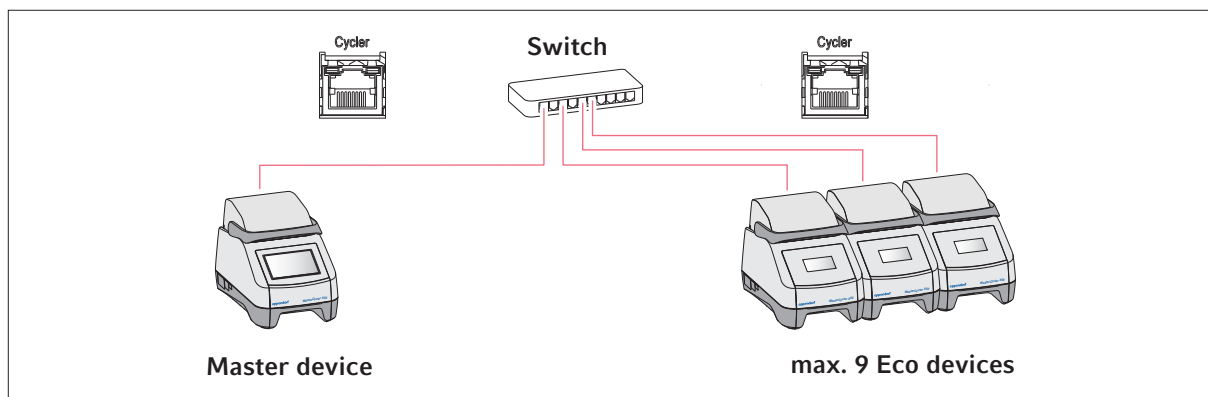

1. Connect the master device to the Ethernet switch via the **Cyclor** port.
2. Connect the eco devices to the Ethernet switch via the **Cyclor** ports.  
The eco devices are recognized by the master device and can be assigned to the master device (see *Assignment on p. 78*).

## 4.3 Decommissioning



Programs on connected eco devices continue to run when the master device is switched off.

If the Mastercycler X50 is not in use for more than one week, the following steps must be carried out:

1. Load the block with an empty PCR plate or tube.
2. Close the heated lid and flip the handle forwards.  
The closed lid prevents contamination of the thermoblock.
3. Disconnect the Mastercycler X50 from the power supply.

## 4.4 Registering the device

To register a VisioNize onboard device for VisioNize Services, a connection to the local network with Internet access is required. If the device is connected to the Internet, it can be logged into VisioNize via the administrator account access data. Further information on logging the device in to VisioNize can be found in the "VisioNize Lab Suite" software manual at <https://www.eppendorf.com>.

### 4.4.1 VisioNize onboard devices

#### Prerequisites:

- Available Ethernet port near the device
- Standard Ethernet cable
- Internet access
- Administrator account (Tenant) for VisioNize



Prevention of data loss, loss of samples or misuse of data

- ▶ Protect the VisioNize onboard device from unauthorized access via the Internet.  
Contact IT systems administration for questions.



Security risks

- ▶ Only enable OPC/REST when required. Every communication protocol used to transmit data via the Internet represents a potential security risk.

#### Connecting to the network

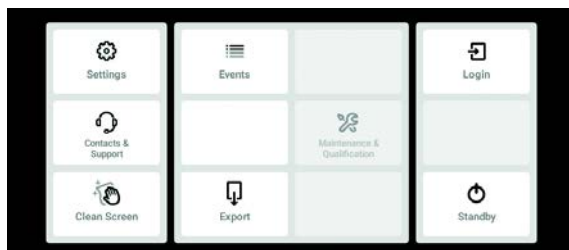

1. Connect the Ethernet port of the device to the local network with a standard Ethernet cable via an available Ethernet port.
2. To check the network connection, tap the *Settings* button.
3. Tap *Menu>Settings>System Settings>Network*.

## DHCP

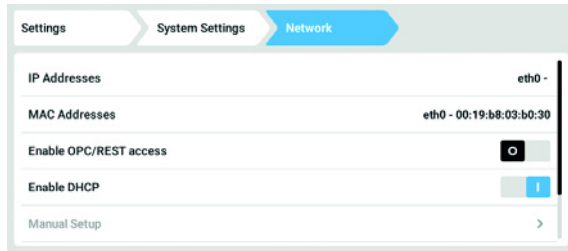

4. The device can be easily integrated into the network using the DHCP network protocol. Enable the *Enable DHCP* slider.
5. If no DHCP is in use, disable *Enable DHCP*.
6. Tap the *Manual Setup* button.
7. Enter the device parameters for the network.
8. To check the entries: Call *Menu>Settings>System Settings>Network*.

When the device has been integrated into the network, the IP address of the device will appear next to *IP Addresses*.

If the IP address is not displayed, note the MAC address and contact IT systems administration.



## 5 Operation

### 5.1 First steps

Before the Mastercycler X50 is used for the first time, the following points must be met:

- The device has been correctly connected.
- The device is free from any damage.
- The free circulation of air around the ventilation gaps at the rear of the device and at the fan between the front stabilizing feet is ensured.

#### 5.1.1 Switching on the device

1. Use the main/power switch at the rear of the device to switch on the device.

The status lamp lights up and the fan starts.  
The software starts.

#### 5.1.2 Opening the heated lid

The Mastercycler X50 is equipped with a heated lid. The heated lid automatically adjusts to the height of the PCR tubes or PCR plates that are used. It is designed for one-hand operation. A manual adjustment to the tube height or adjusting the contact pressure to the tube lids is not required.

The heated lid ensures a uniform contact pressure between the tubes and the thermoblock and protects the tube lids against leaks. The heating process prevents the formation of condensate in the upper area of the tube during the temperature control of the reaction liquid.



**WARNING! Biohazard when tempering with the heated lid open.**

When tempering with an open heated lid, the lids of the reaction vessels can spring open. This will release sample material.

- ▶ Only temper with a closed heated lid.



**CAUTION! Risk of burns on the thermoblock, heated lid and reaction vessels.**

The thermoblock, heated lid and reaction vessels reach temperatures of over 50 °C very quickly.

- ▶ Wait until the temperature of the thermoblock, heated lid and reaction vessels is below 30 °C.
- ▶ Then open the heated lid.

- 
- ▶ Flip up the lid handle as far as it will go.

### 5.1.3 Closing the heated lid



**CAUTION! Risk of crushing when closing the heated lid.**

- ▶ Hold the middle of the handle on the heated lid.
- ▶ When you close the heated lid, do not place your fingers between the heated lid and the housing.



Always make sure that the thermoblock is loaded with PCR tubes of the same type only to ensure that the tubes are all of the same height. The tubes all need to be of the same height to ensure that they are pressed into the thermoblock evenly.

1. Load the thermoblock with PCR tubes or a PCR plate.

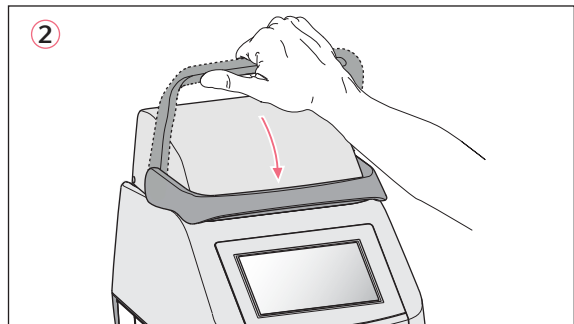
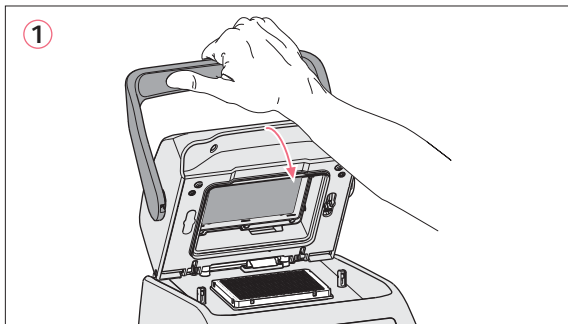

2. Close the heated lid **(1)**.
3. Move the lid handle further down and lock it **(2)**.





The force required for locking the heated lid depends on the type of PCR tubes or the PCR plate used.

The device is ready for operation.



## 5.2 Operating the user interface

 The touch screen is designed to be operated with your fingers only without the need for any auxiliary equipment. Laboratory gloves made from nitrile or latex can be worn. Alternatively, a capacitive touch pen can be used for capacitive touch screens, e.g., if thicker gloves have to be worn in the laboratory.

 If any liquid comes into contact with the touch screen, the functions that are displayed on the touchscreen may be triggered.

- ▶ Do not drip any liquids onto the touch screen.
- ▶ Do not spill any liquids onto the touch screen.

### 5.2.1 Logging in and out as a user

Prerequisites

User administration has been set up

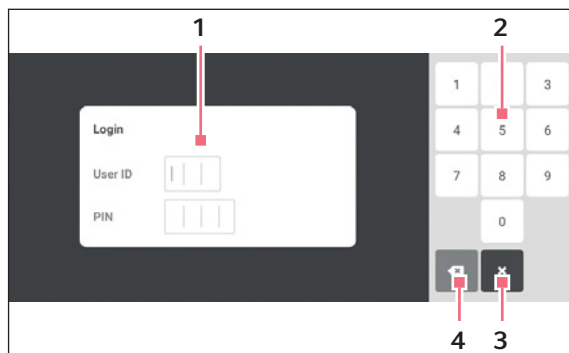

1 Edit box

2 Number pad

3 Cancel login

4 Delete the entry step by step

#### Logging in as a user

1. Tap the *Login* button.
2. Enter your user ID or user name.
3. Enter your PIN or password.

If the correct PIN or password has been entered, the user is logged in automatically.

#### Logging out as a user

1. Tap the *Logout* button.

 As an alternative to the *Logout* button in the toolbar, the user can also log off in the *Menu*.

## 5.2.2 Home screen

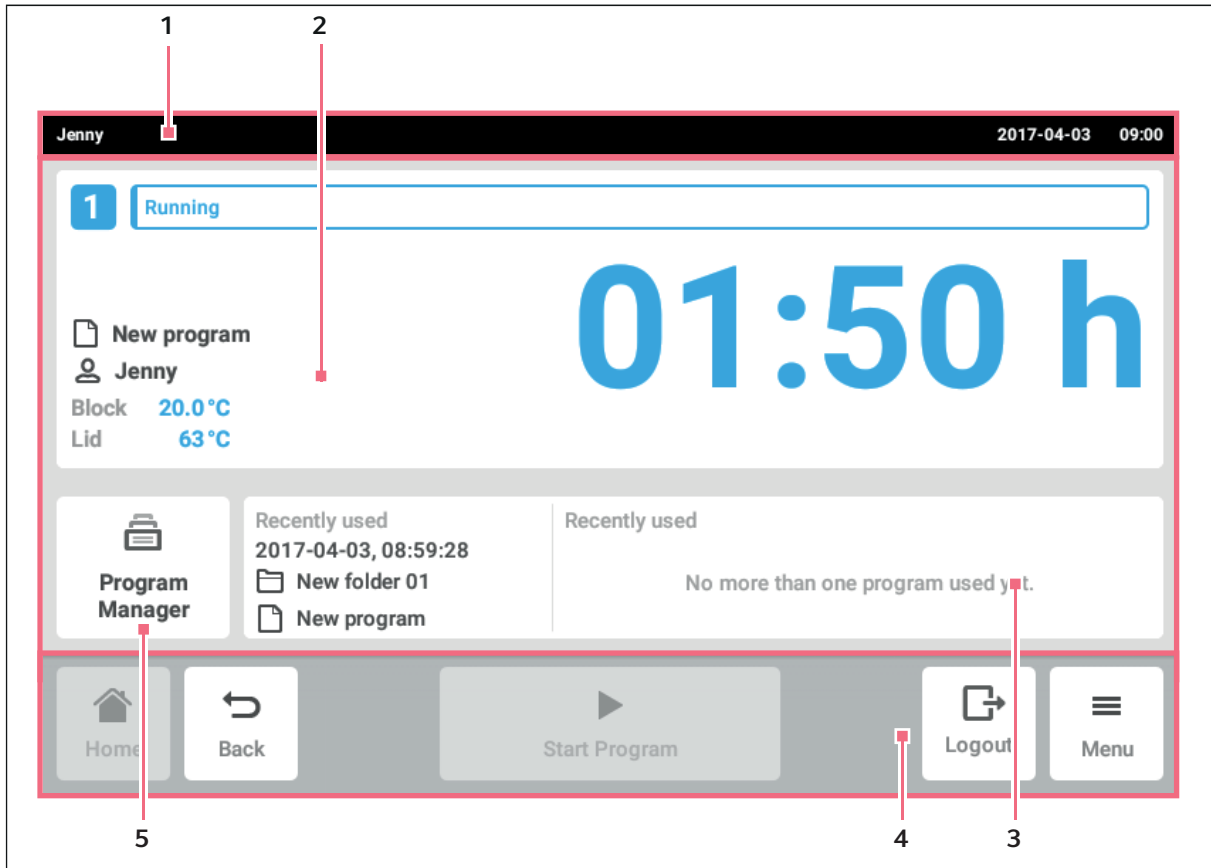

Fig. 5-1: Home screen

### 1 Status bar

User name if the user has logged in using user administration.  
 Device name if a name has been entered.  
 Date and time

### 2 Current information about the device status and the selected program.

### 3 Display of recently used programs or recent users.

### 4 Toolbar

Buttons for the navigation and operation of the device

### 5 Program Manager

The toolbar **(4)** contains the buttons for navigating within the software. The toolbar is always visible.

- *Home*: The home screen is displayed.
- *Back*: The previous window is displayed.
- *Menu*: The menu items that are available for the device are displayed (see *Menu on p. 31*).

## 5.3 Menu

### 5.3.1 Opening the menu

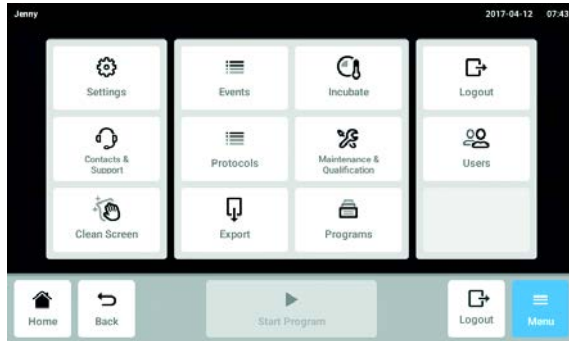

1. Tap the *Menu* button.  
The menu items that are available for the device are displayed.
2. Select the menu item.

### 5.3.2 Events

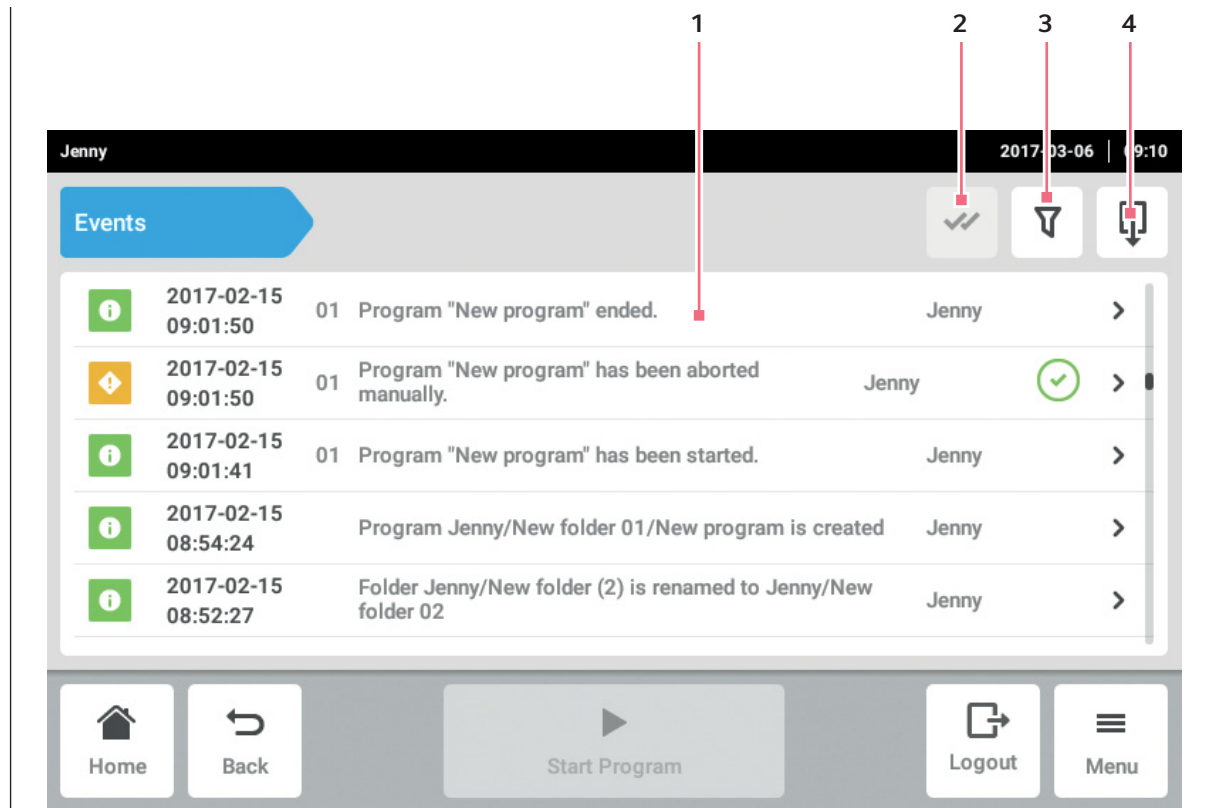

Fig. 5-2: *Events* window

- |  |  |
|--|--|
| <p><b>1 List of all notifications and messages</b></p> <p><b>2 Confirm any open notifications.</b></p> | <p><b>3 Filter options</b><br/>       The button is highlighted in blue when messages are filtered.</p> <p><b>4 Export list of messages to a USB storage medium.</b></p> |
|--|--|



500000 notifications and messages are saved. If there are more than 500000 entries, the oldest entries are overwritten.

#### Accessing *Events*

1. Tap the *Menu* button.
2. Tap the *Events* button.

## Filtering the event list

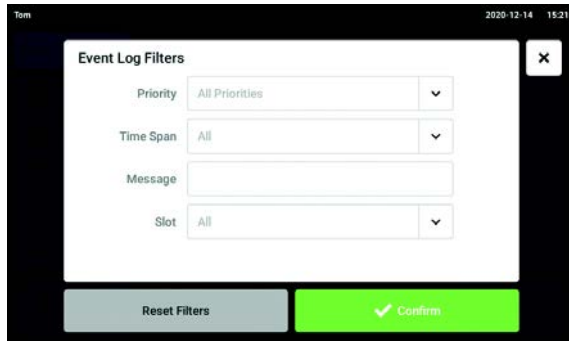

3. Tap the button for the filter options.  
The window with the filter settings opens.
  - *Priority*
  - *Time Span*
  - *Message*
  - *Slot*If a filter is enabled, a checkmark appears next to the filter.  
Tap the *Clear all filters* button to disable all filters.
4. Close the selection window.  
The filtered notifications and messages are displayed.

## Accessing more information

1. Select a notification or message from the event list.  
The window with detailed information appears.
2. Use the arrow keys to navigate between the notifications and messages.

## Exporting the event list

1. Connect a USB stick and tap the *Export* button.  
The event list is saved as an Excel table. If the export was successful, the *Export successful* window appears.
2. Confirm the message to complete the process.

### 5.3.3 Protocols



1 000 program runs can be saved. If there are more than 1 000 programs, the oldest programs are overwritten.

#### Opening logs

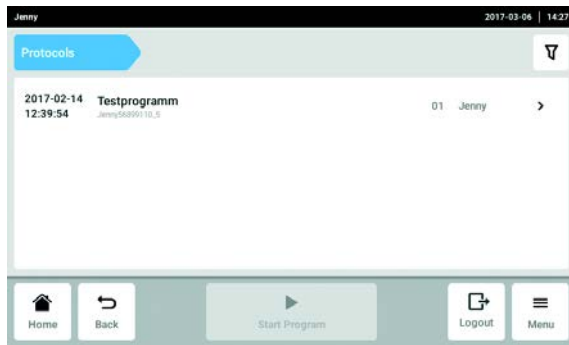

1. Tap the *Menu* button.
2. Tap the *Protocols* button.  
The list of logged programs appears.

#### Filtering logs

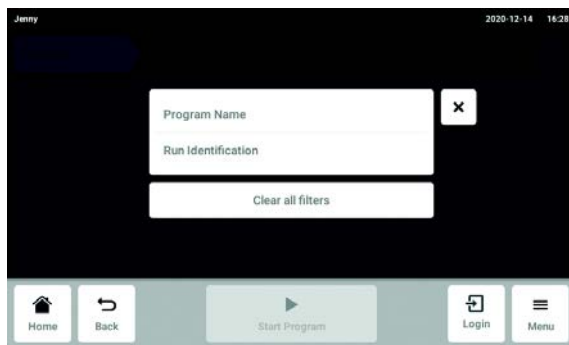

3. Tap the button for the filter options.  
The window with the filter settings opens.
  - *Program Name*
  - *Run Identificaion*
 If a filter is enabled, a checkmark appears next to the filter.  
 Tap the *Clear all filters* button to disable all filters.
4. Close the selection window.  
The filtered logs are displayed.

## Information window

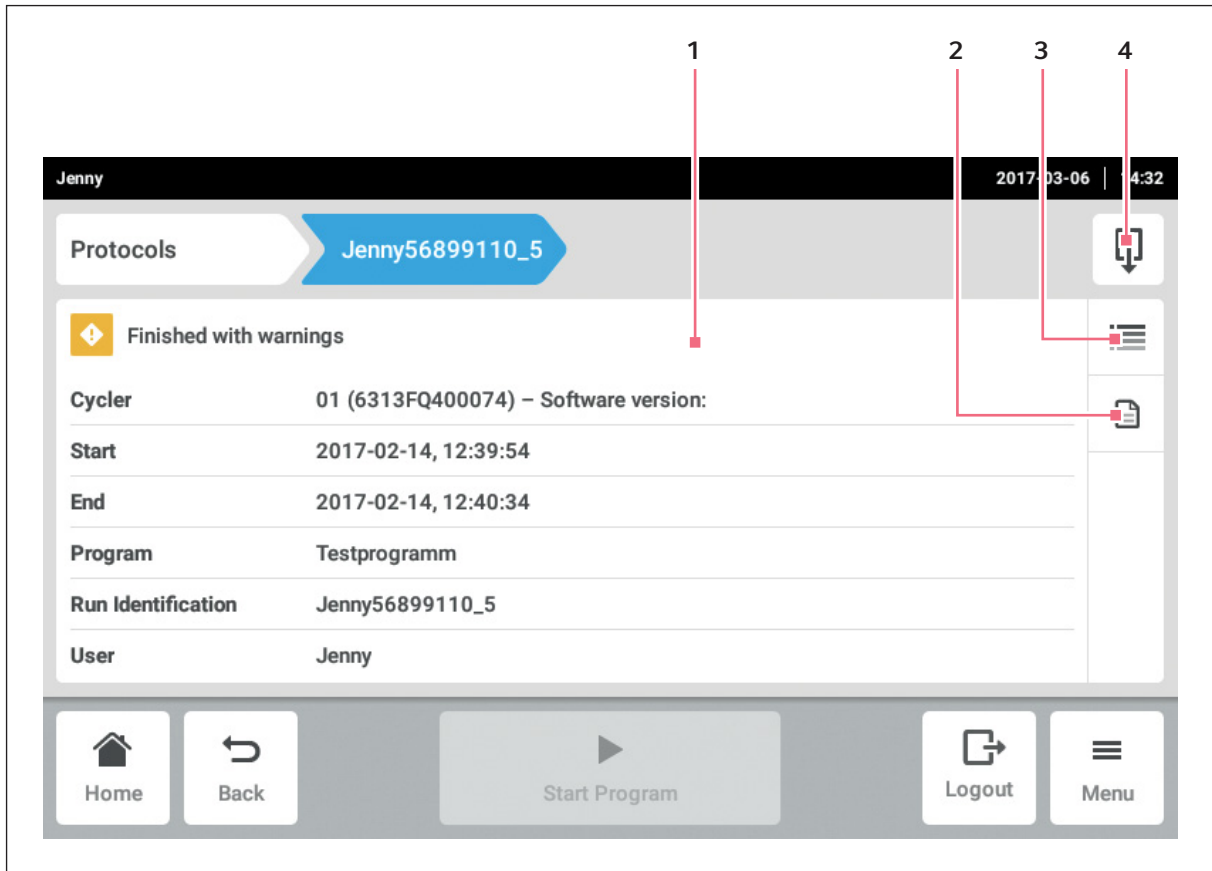

Fig. 5-3: Information window of a log

- 1 General information on the program
- 2 Information on the program settings

### 3 Details

### 4 *Export* button

A log with information on the program can be saved as a PDF file.

1. Select the log.  
The information window of the log is displayed.

### 5.3.4 Export

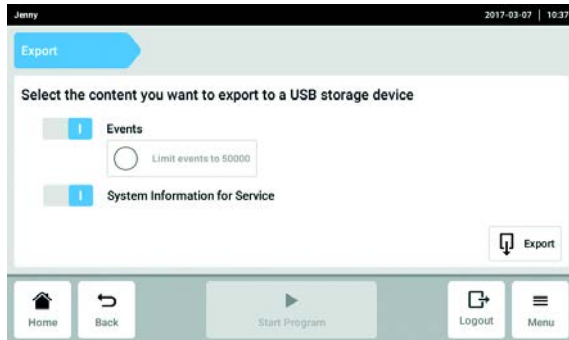

1. Tap the *Menu* button.
2. Tap the *Export* button.  
A selection list for the export appears.
3. Connect a USB stick.
4. Select the data for the export.
5. Tap the *Export* button to export the selected data.  
The data is saved. If the export was successful, the *Export successful* window appears.
6. Confirm the message to complete the process.

### 5.3.5 Incubate

The thermoblock and the lid can be temperature controlled independently of a PCR run.

The *Incubate* function can be set separately for all connected devices.

#### Accessing the *Incubate* function

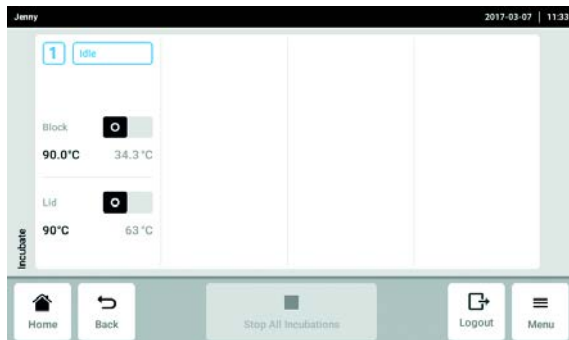

1. Tap the *Menu* button.
2. Tap the *Incubate* button.

#### Setting the *Incubate* function.

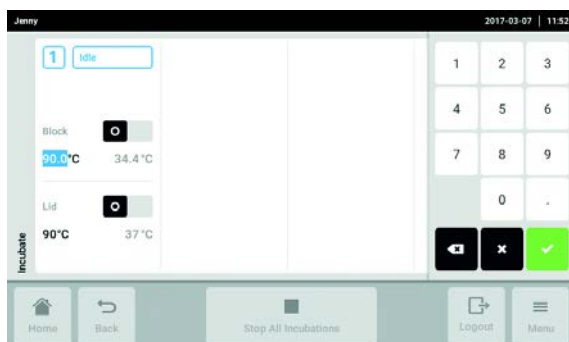

3. Set the temperature for the thermoblock.
4. Use the switch to enable the *Incubate* function for the thermoblock.
5. Set the temperature for the lid.
6. Use the switch to enable the *Incubate* function for the lid.



### Ending the *Incubate* function



7. To end the *Incubate* function for all devices, tap the *Stop All Incubations* button.
8. To end the *Incubate* function for individual devices, switch off the corresponding *Block* or *Lid* switches.

### 5.3.6 Maintenance & Qualification

*Maintenance & Qualification* can be used to perform defined *Recurring Tasks*. If the device was disqualified automatically due to an overdue task this information is displayed on a button below the *Recurring Tasks* button. After tapping this button a window opens in which the device can be requalified and the setting *Warn & Disqualify* can be changed to *Warn*.

The functions in the *Maintenance & Qualification* menu item can be opened separately for all connected eco devices.

#### Accessing the *Maintenance & Qualification* function

1. Tap the *Menu* button.
2. Tap the *Maintenance & Qualification* button.

## Performing a *Verification*

### Prerequisites

Verification requires a Temperature Verification System.



Verification using the multi-channel system is described in the operating manual of the "Temperature Verification System – T6".

Verification using the single-channel measuring device can only be performed by an administrator or a user with standard access rights.

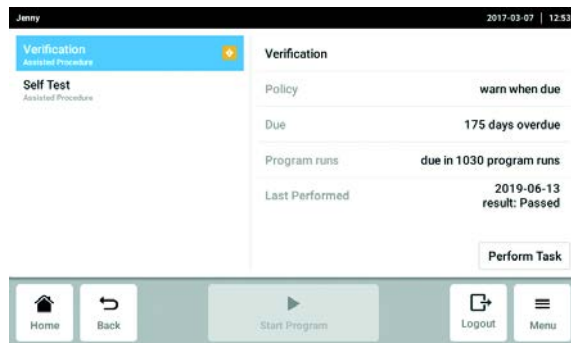

1. Tap the *Recurring Tasks* button.
2. Tap *Verification*.
3. Tap the *Perform Task* button.

4. Follow the instructions displayed by the software.
5. Export the certificate to a USB stick after taking the measurement.



The certificate can only be exported to a USB stick immediately after taking the measurement.

## Performing a *Self Test*

All users can perform a self test.

The master variants of the Mastercycler X50 have an integrated self test function. The self test function provides a simple way of testing the correct function of the master device and the connected eco devices without any auxiliary equipment.

1. Tap the *Self Test* button and select the device.
2. Tap the *Perform Task* button and select the device.
3. Follow the instructions displayed by the software. The results are displayed at the end of the self test.
4. Connect a USB stick and tap the *Export* button. The certificate is saved as a PDF file. If the export was successful, the *Export successful* window appears.
5. Confirm the message to complete the process.

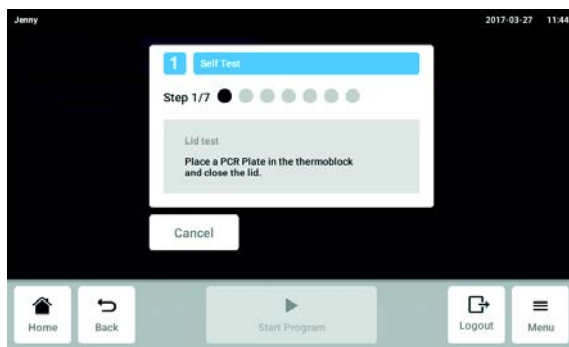

The certificate can only be exported to a USB stick immediately after taking the measurement.



## **6 User administration**

### **6.1 The user administration concept**

The user administration can be used to organize access to the Mastercycler X50. There are three user roles:

- Administrator
- User with standard rights
- User with restricted rights

#### **6.1.1 Administrator**

The administrator has additional rights:

- Configuring Mastercycler X50
- Access to user administration

#### **6.1.2 User with standard rights**

A normal user can operate the Mastercycler X50 without restrictions and create new programs and folders.

#### **6.1.3 User with restricted rights**

A user with restricted rights can operate the Mastercycler X50 with certain restrictions, i.e. select, start and stop existing programs.

#### **6.1.4 User rights without user administration**

Without user administration all users have the same rights an administrator has.

### 6.1.5 User rights

Tasks	User with restricted rights	User with standard rights	Administrator/ operator (rights without user administration)
Export logs	x	x	x
Login/Logout	x	x	x
Changing your own password	x	x	x
View administrator settings (does not apply for user administration)	x	x	x
View device information	x	x	x
View logs	x	x	x
Start self test	x	x	x
View programs	x	x	x
View program folder	x (shared)	x	x
Select program for PCR run	x	x	x
Enter run ID	x	x	x
Start PCR run	x (released programs only)	x	x
Interrupt PCR run	x	x	x
Stop PCR run	x	x	x
Select incubation temperature	x	x	x
Start incubation	x	x	x
Stop incubation	x	x	x
View user settings	x	x	x
View <i>Program information</i>	x	x	x
Identify last error	x	x	x
Set service intervals	x	x	x
Use <i>Sketch mode</i>		x	x
Import and export programs	x (export only)	x	x
Edit programs		x	x
Assign programs to a folder		x	x

Tasks	User with restricted rights	User with standard rights	Administrator/ operator (rights without user administration)
Create, edit and delete a folder		×	×
Cut, copy and paste the contents of a folder		×	×
Delete the contents of a folder		×	×
Maintain programs (protected program access)		×	×
Select program templates		×	×
Release a program		×	×
Define access rights for folders			×
Share folders		×	×
Verify a device		×	×
Set the <i>Auto Restart</i> function			×
Set the acoustic alarm			×
Assign eco devices to the system			×
Configure network settings			×
Create a user account			× (administrator)
Updating the software	×	×	×
<i>Qualification status</i> accounts			×
Change a user name			×
Change user rights			×
Reset a user password			×
Deleting a user account			×

## 6.2 Defining settings in the user administration

### 6.2.1 Creating an administrator

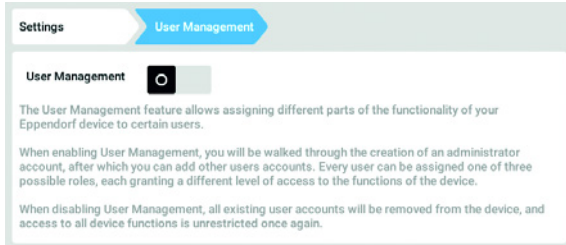

1. Tap the *Menu* button and navigate to the *Settings* > *User Management* menu item.
2. To activate the user administration, slide the *User Management* switch to the *I* position. The *Login mode* window appears.

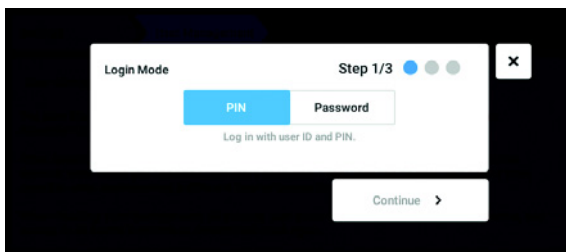

3. Define the login mode for all users.
4. Continue the process with *Continue*. The *Administrator credentials* window appears.

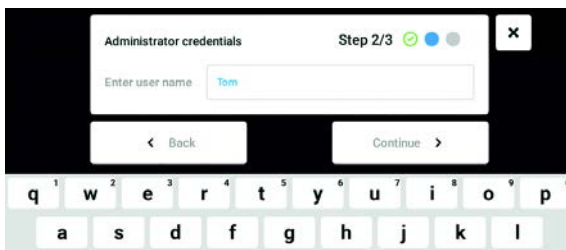

5. Enter the user name for the first administrator in the *Enter User Name* field.
6. Continue the process with *Continue*. The *Administrator credentials* window appears.

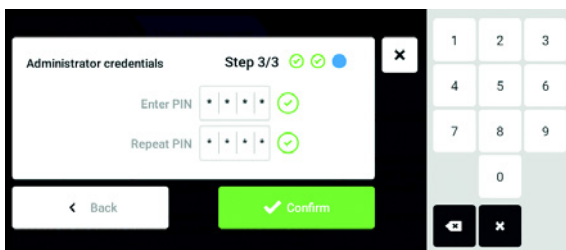

7. Enter PIN or password in the *Enter PIN/Password* field. Confirm the entry in the *Repeat PIN/Password* field.
8. Continue the process with *Continue*. The *User Management successfully enabled* window appears. The user administration is activated. The user account for the first administrator is created.

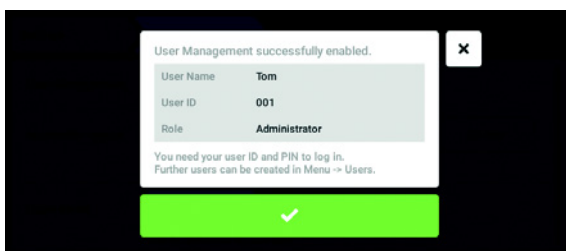

9. Confirm the message. The *User Management* window appears. It is now possible to edit the user administration.



## 6.2.2 Editing the user administration

### Prerequisites

- The administrator is logged in.

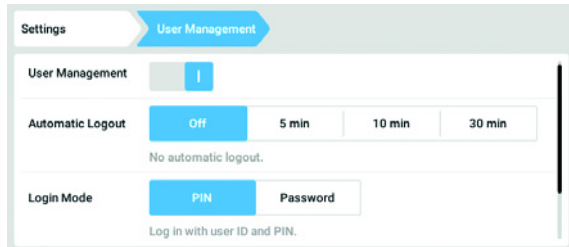

1. Tap the *Menu* button and navigate to the *Settings* > *User Management* menu item.

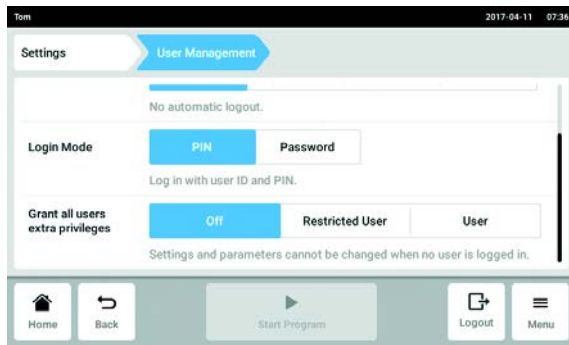

2. Define the settings for the user administration.

- *User Management*: Switch the user administration on and off.
- *Automatic Logout*: Define the time after which a user is automatically logged out if the touch screen is not used.
- *Login Mode*: Define the login mode for all users.
- *Grant all users extra privileges*: Restricted rights (*Restricted User*) or standard rights (*User*) are active for all users.



When the *Grant all users extra privileges* option is activated, a login is not necessary. Also, users who are not recorded in the user administration can operate the device with these rights (*Restricted User / User*).

### 6.2.3 Deactivating the user administration



#### NOTICE! Data loss in case of deactivation of the user administration

Deactivating the user administration deletes all user accounts.

- ▶ Check whether deactivation of the user administration is required.
- ▶ Inform all users that the user accounts have been deleted.

#### Prerequisites

- The administrator is logged in.

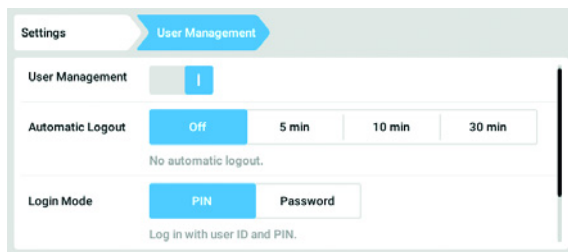

1. Tap the *Menu* button and navigate to the *Settings* > *User Management* menu item.
2. To deactivate the user administration, slide the *User Management* switch to the *Off* position. The *Disabling User Management* window appears.

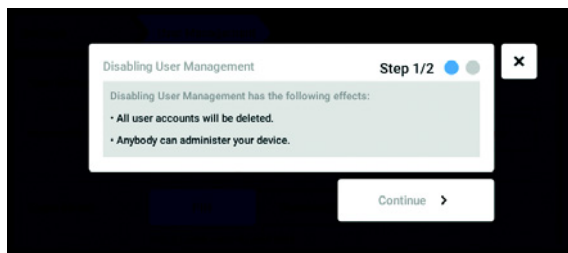

3. Continue the process with *Continue*. The *Confirm deleting all user accounts* window appears.

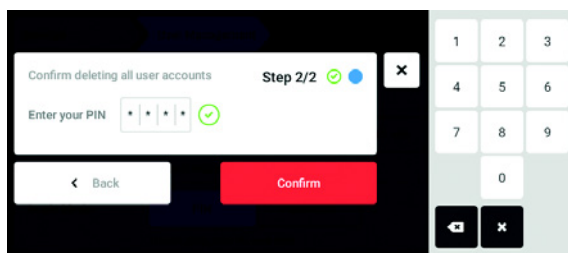

4. Enter the PIN/password.
5. Complete the process with *Continue*. The user administration is deactivated. All user accounts are deleted.

## 6.3 Editing user accounts as administrator



### NOTICE! Risk of data loss due to loss of the administrator password.

The administrator can only change their password or PIN with their access data. If the administrator's access data is lost, it will not be possible to make changes to the user administration or to the system settings. In this case, the device will have to be reset to the factory settings by an authorized service technician. All user accounts and any data and settings stored on the device will be deleted.

- ▶ Create a second user account with administrator rights.
- ▶ Keep the administrator password secure.

### 6.3.1 Creating a user account



999 user accounts can be created.

#### Prerequisites

- The administrator is logged in.

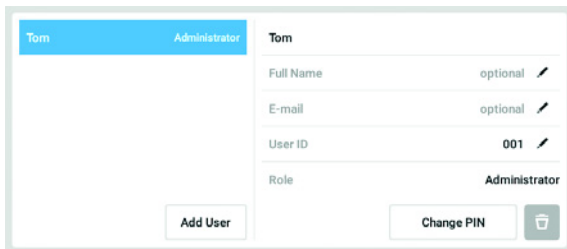

1. Tap the *Menu* button and navigate to the *User* menu item.  
The list with the user accounts is displayed.
2. Tap the *Add User* button.  
The *Enter user name for the new user* field appears.

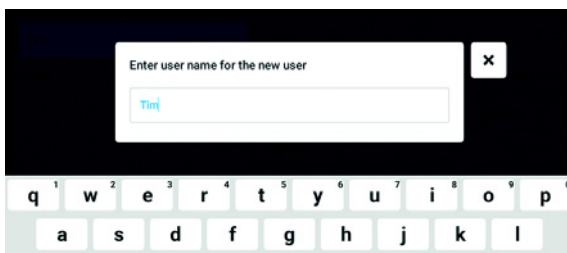

3. Enter the user name.  
The *User credentials* window appears.  
The user account has been created. The user data appears in the window.  
The user has been assigned to the *Restricted User* user group.
4. Confirm the entry.

### 6.3.2 Editing user accounts



Users with restricted rights or standard rights can only edit their own entries for *Full Name* and *E-mail*. Users can always change their own password or the PIN. Administrators can assign a new user ID to a user account and change the user rights.

#### Prerequisites

- The administrator is logged in.

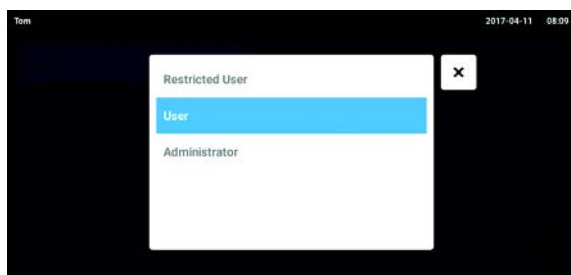

1. Tap the *Menu* button and navigate to the *User* menu item.  
The list with the user accounts is displayed. Editable entries are indicated by a black pen symbol.
2. Select the user account.
3. Option: Enter the full name.
4. Option: Enter the e-mail address.
5. Tap *User-ID* to change the user ID.
6. Select a new user ID.
7. Tap *Role* to change the user group and the associated rights.  
The list with the available user groups is displayed.
8. Assign a user group to the user.
  - Restricted User
  - User
  - Administrator

The selected parameters are stored and will appear in the user account.

### 6.3.3 Deleting a user account

#### Prerequisites

- The administrator is logged in.



1. Tap the *Menu* button and navigate to the *User* menu item.  
The list with the user accounts is displayed.
2. Select the user account that is to be deleted.
3. Tap the *Recycle bin* symbol.  
The *Confirm the deletion of:* window appears.

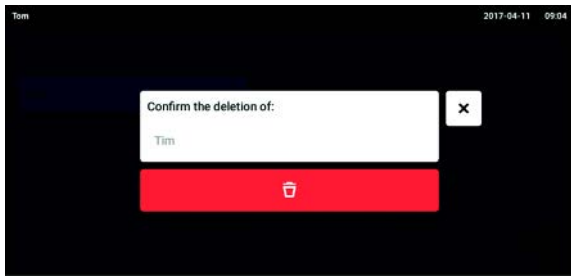

4. Confirm that you want to delete the user account. The user account is deleted.

### 6.3.4 Resetting the password/PIN for a user account

If a user has forgotten his password/PIN, the administrator can generate a new password/PIN.



The administrator can only change his password or PIN with his current access data. If the administrator's access data is lost, it will no longer be possible to make any changes in the user administration.

In this case, the device will have to be reset to the factory settings by an authorized service technician. This means that all user accounts and programs, log files and logs which are stored on the device will be deleted.

- ▶ Create a second user account with administrator rights.

#### Prerequisites

- The administrator is logged in.

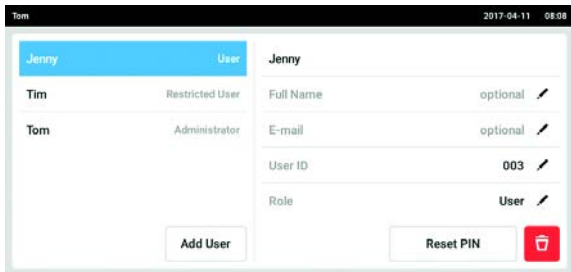

1. Tap the *Menu* button and navigate to the *User* menu item. The list with the user accounts is displayed.
2. Select the user account.
3. Tap the *Reset Password/PIN* button. The *Do you want to reset the Password/PIN for:* window appears.
4. Tap *Reset* to confirm the action. The *New Credentials* window appears. The new password/PIN is created automatically.

## 6.4 Administrating your own user account

Users can only edit their own *Full Name* and *E-mail* entries. Users can always change their own PIN or password.

Prerequisites

- The user is logged in.

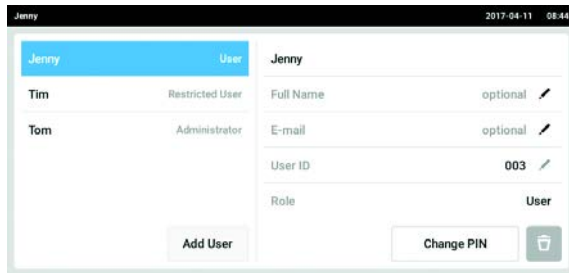

1. Tap the *Menu* button and navigate to the *User* menu item.  
The list with the user accounts appears. Entries indicated by a black pen can be edited.
2. Select the user account.
3. Optional: Enter the full name.
4. Optional: Enter the e-mail address.
5. To change the password/PIN, tap the *Change Password/PIN* button.
6. Enter the current password/PIN in the *Enter current Password/PIN* field.
7. Enter the new password/PIN in the *Enter new Password/PIN* and *Repeat new Password/PIN* fields.
8. Confirm your entry.  
The message *Password/PIN successfully changed* appears.  
The new password or the new PIN is active.

7 Programming  
 7.1 Overview of the *Program Manager*  
 7.1.1 Accessing the *Program Manager*

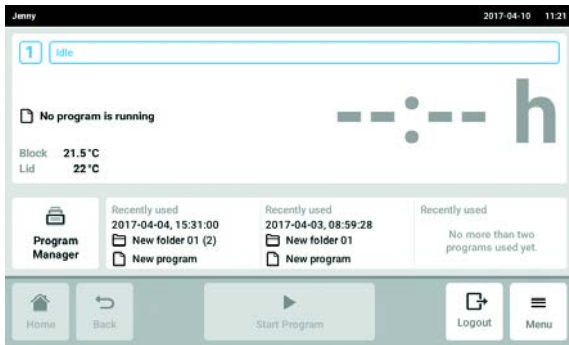

► Tap the *Program Manager* on the home screen. The window with the *Program Manager* is displayed.



The *Program Manager* can also be accessed from the *Menu* using the *Programs* button.



The available folders and programs are displayed in accordance with user rights.

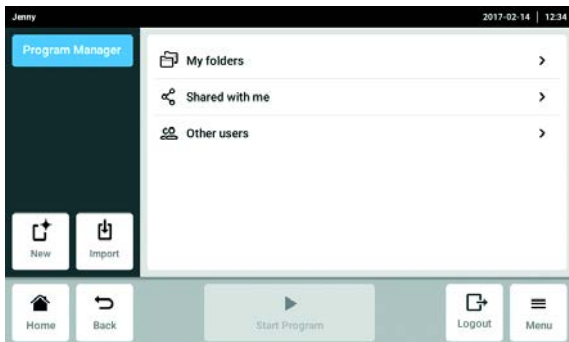

- *New* button: Create new folders or new programs.
- *Import* button: Import folder and programs from a USB stick. Programs from Mastercycler nexus or Mastercycler pro can be imported here. Controlled ramps and simulated devices will not be transferred.
- *My folder* folder: Folders for your own subfolders and programs
- *Shared with me* folder: In this folder all subfolders and programs are displayed that other users have released for the user who is currently logged in.
- *Other users* folder: Other users can access subfolders and programs if they have the corresponding user rights.
- *Lost and Found* folder (not shown): This folder is only visible to the Administrator, it contains deleted programs and folders of all users.

## 7.2 Creating a new folder



You can create up to 500 folders.

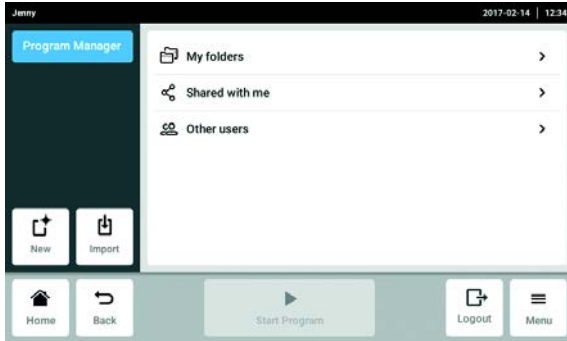

1. Tap the *New* button.

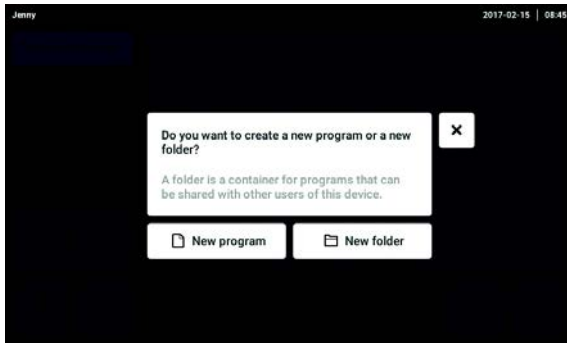

2. Select *New folder*.

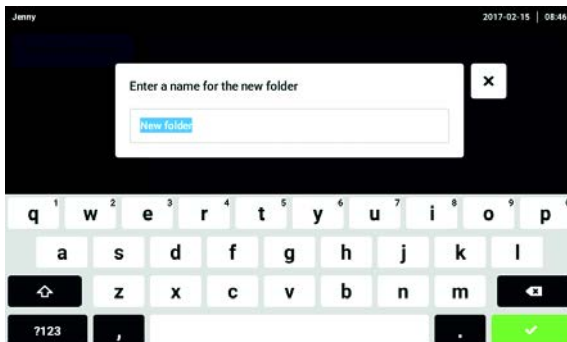

3. Enter a name for the folder.

4. Confirm your entry.

The new folder is displayed under *My folders*.



### 7.3 Administration of folders

1. Tap the ... button to the right of the folder name. The folder editing options are displayed.

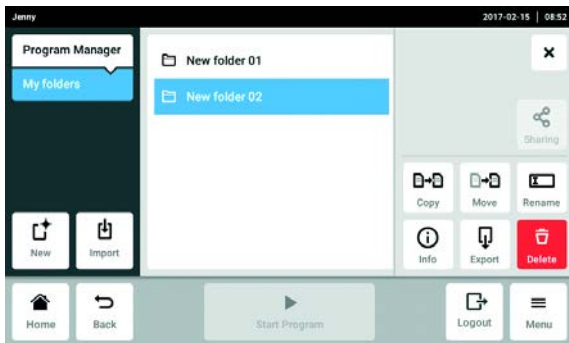
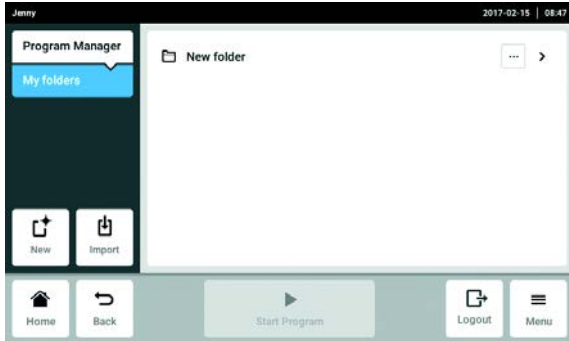

- *Sharing* button (administrator and users with standard rights): Share a folder with other users.
- *Copy* button: Copy folder
- *Move* button (administrator only): Move folder from *Lost and Found* to *My folders*.
- *Rename* button: Rename folder
- *Info* button: Information about folder
- *Export* button: Copy folder to a USB stick
- *Delete* button: Delete a folder

### 7.4 Creating a new program



You can create and save up to 5000 programs.

1. Tap the *New* button.

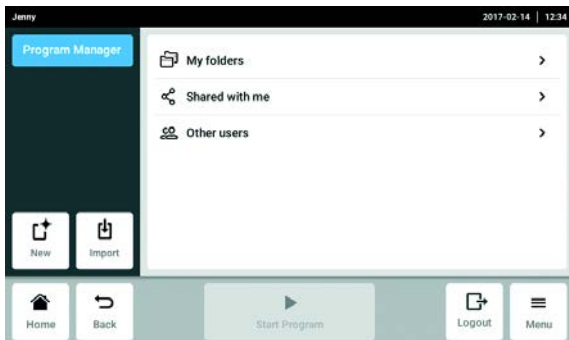

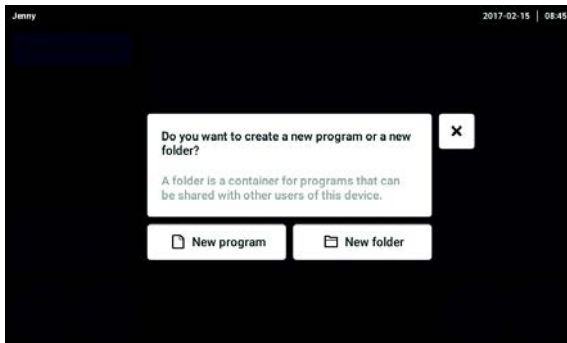

2. Select *New program*.

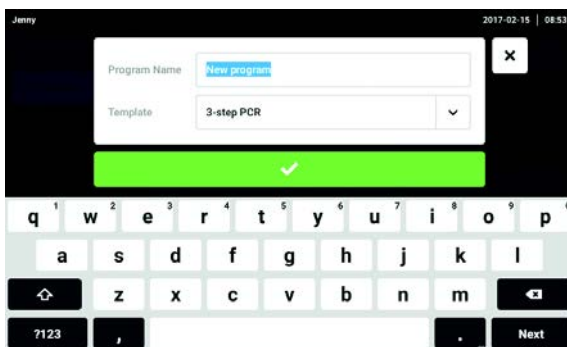

3. Enter a name for the program.
4. Select the template.
5. Confirm your entry.

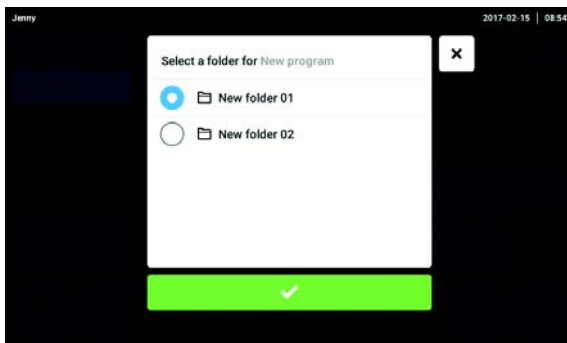

6. Select and confirm the folder for the new program.

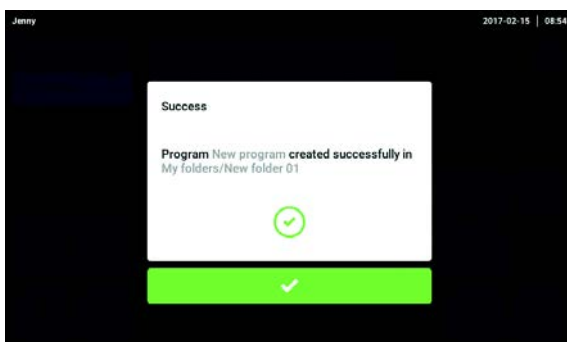

7. Confirm the displayed message.  
The new program is displayed in the selected folder.

## 7.5 Administration of programs

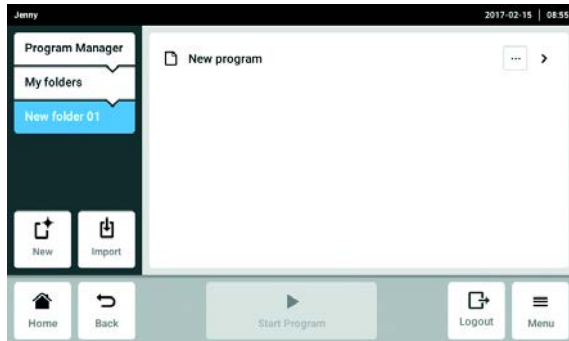

1. Tap the ... button to the right of the program name.  
The program administration options are displayed.

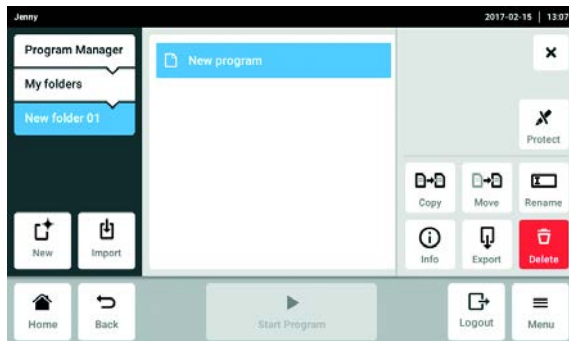

- *Protect* button: Protect program (*Read only* or *Write and read*)
- *Copy* button: Duplicate a program
- *Move* button: Move program to another folder
- *Rename* button: Rename program
- *Info* button: Information about program
- *Export* button: Copy program to a USB stick
- *Delete* button: Delete program

## 7.6 General program settings

### 7.6.1 Header

The header contains general settings for a program which can be edited using the *Edit Settings* button.

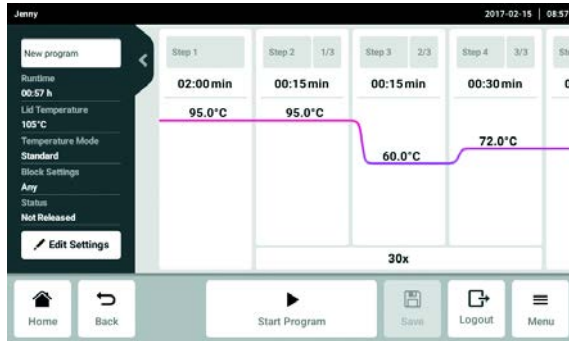

The following information is displayed:

- Name of the program
- *Runtime*  
 Under *Runtime* either the estimated or the desired run time is indicated.
  - The estimated run time is calculated from the PCR program and the settings for the block temperature control mode, the block type and the heating and cooling rates.
  - The desired run time is based on the activated function *Desired runtime* and the value for the run time that was entered manually.
- *Lid Temperature*  
 Under *Lid Temperature* the set lid temperature is indicated.
- *Temperature Mode*  
 Under *Temperature Mode* the selected block temperature control mode is indicated.
- *Block Settings*  
 Under *Block Settings* the selected block type is indicated.
- *Status*  
 Under *Status* the selected program status is indicated.

## 7.6.2 Editing the general program settings

Prerequisites

Program has been selected.



1. Tap the *Edit Settings* button.

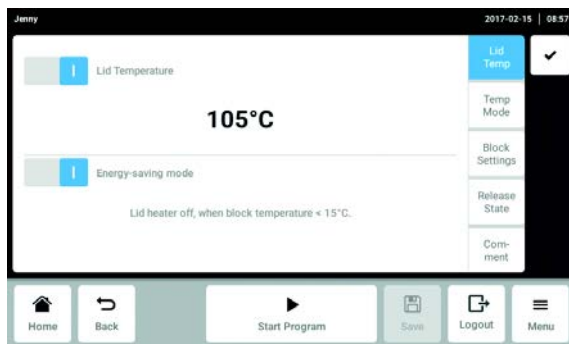

2. Adjust the settings or add a comment.
- *Lid Temp*: Set the lid temperature
  - *Temp Mode*: Select the block temperature control mode
  - *Block Settings*: Set the block type, limit the heating and cooling rates and set the run time
  - *Release State*: Select the program status
  - *Comment*: Add a comment for the program

3. Confirm the settings.

### 7.6.3 Setting the lid temperature

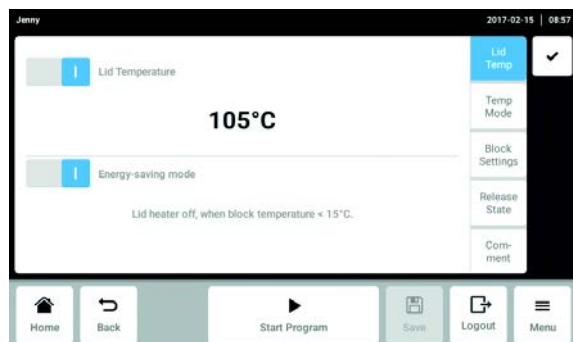

1. Use the *Lid temperature* switch to enable or disable the heated lid temperature.

#### Prerequisites

Lid temperature has been enabled.

2. Tap the value, enter the new value using the number pad and confirm the entry.
3. Use the *Energy-saving mode* switch to enable or disable the power saving mode.

### 7.6.4 Selecting the block temperature control mode

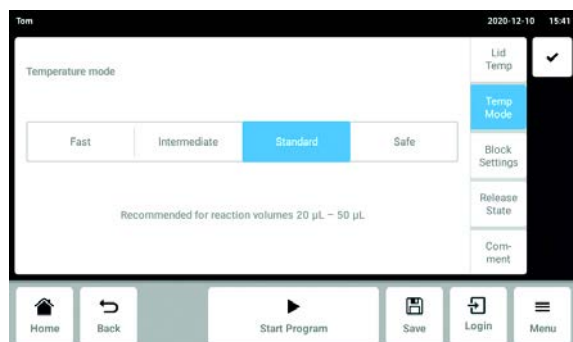

1. Tap the *Fast*, *Intermediate*, *Standard*, or *Safe* button.

## 7.6.5 Performing block settings

### Selecting the block type

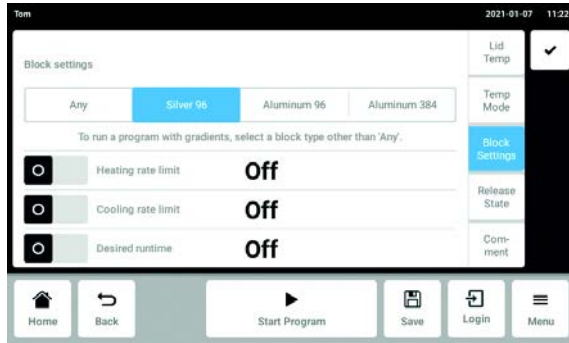

1. Tap the *Any*, *Silver 96*, *Aluminum 96*, or *Aluminum 384* button to select a block type.

### Limiting the heating rate

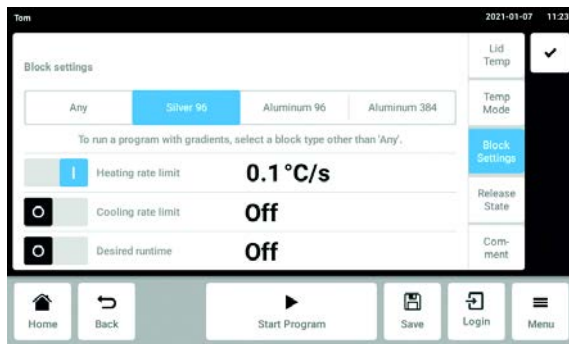

2. Use the *Heating rate limit* switch to enable or disable the heating rate.



If the *Heating rate limit* function is disabled, the device automatically uses the maximum value.

### Prerequisites

Heating rate has been enabled.

3. Tap the value, enter the new value using the number pad and confirm the entry.

### Limiting the cooling rate

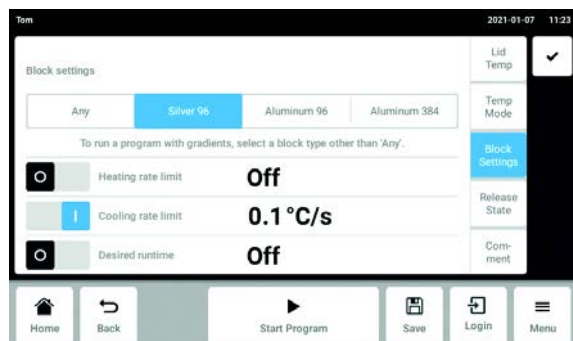

- Use the *Cooling rate limit* switch to enable or disable the cooling rate.



If the *Cooling rate limit* function is disabled, the device automatically uses the maximum value.

#### Prerequisites

The cooling rate has been enabled.

- Tap the value, enter the new value using the number pad and confirm the entry.

### Setting the desired run time

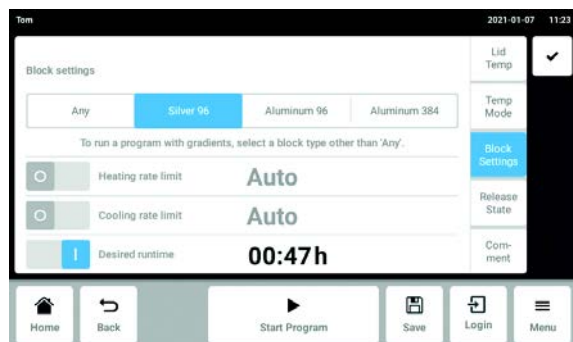

- Use the *Desired runtime* switch to enable or disable the run time.



If *Desired runtime* is enabled, no ramps can be defined.

#### Prerequisites

Run time has been enabled.



When it is enabled, the run time specified by the set block type is displayed automatically.

- Tap the value to change the run time manually. Enter the desired value using the number pad and confirm the entry.

The device calculates the matching ramps for the run time that was entered.



## 7.6.6 Selecting the program status

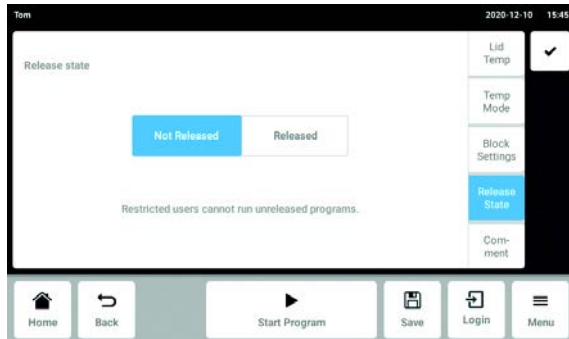

1. Tap the *Not Released* or *Released* button.



Programs with the status "released" cannot be changed and can also be used by users with restricted user rights.

- ▶ Release programs after detailed examination only.

## 7.6.7 Entering a comment

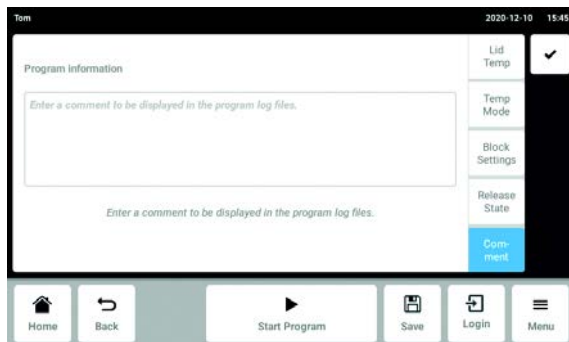

1. Add a comment for the program.

The text is displayed in the log file of the PCR run.

## 7.7 Editing programs

### 7.7.1 Selecting the program step

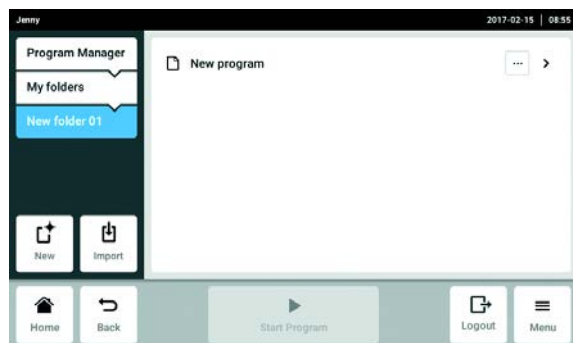

1. Select a program.



2. Select the column with the program step that is to be edited.

The available editing options are displayed next to the program steps.

- *Gradient*: Setting gradients
- *Inc./Dec.*: Incremental change of the temperature and/or holding time until the next cycle
- *Ramp*: Set the temperature control speed of the thermoblock incrementally
- *Add step left*: Add another programming step to the left of the selected programming step
- *Add step right*: Add another programming step to the right of the selected programming step
- *Delete*: Delete a program step

## 7.7.2 Inserting a program step

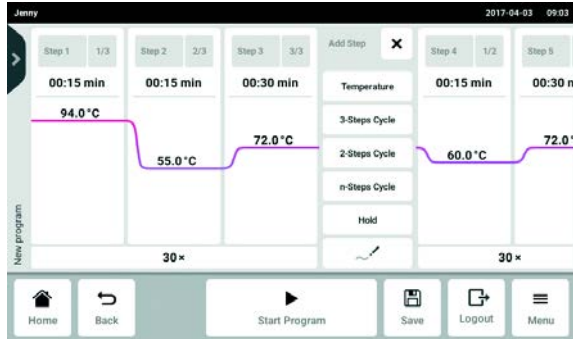

1. Tap the *Add step left* or *Add step right* button.

You can select the following program steps depending on the previous or subsequent program step:

- *Temperature*: Individual temperature step with adjustable block temperature and holding time.
- *3-Steps Cycle*: Cycle program step with 3 temperature steps and an adjustable number of repetitions (1 to 99).
- *2-Steps Cycle*: Cycle program step with 2 temperature steps and an adjustable number of repetitions (1 to 99).
- *n-Steps Cycle*: Cycle program step with up to 40 temperature steps and an adjustable number of repetitions (1 to 99).
- *Hold*: Temperature step with adjustable block temperature and indefinite holding time. The set temperature is maintained until the program is resumed manually.
- *Sketch mode*: Free programming on the touch screen

2. Select a new program step.

The new program step is added to the left or right of the program step that was highlighted earlier.

3. Set the block temperature, holding time and number of repetitions.

4. Tap the *Save* button.

The changed program is saved.

### 7.7.3 Sketch mode



1. Select the column with the program step that is to be edited.
2. Tap the *Add step left* or *Add step right* button.

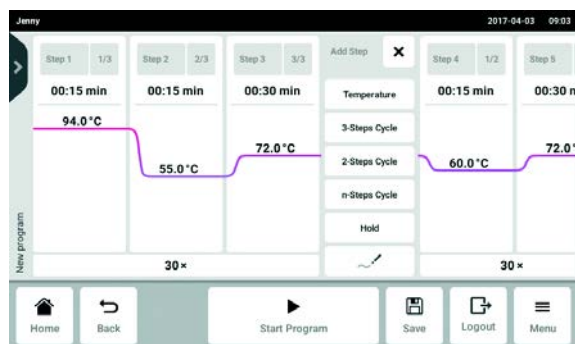

3. Tap the *Sketch mode* button.  
 The start window appears briefly with an explanation of the four functions.
  - Vertical line: This adds a program step. A maximum of 6 program steps are possible.
  - Horizontal line: This sets the temperature for the program step. A curve across several program steps creates a temperature profile.
  - A circle around several program steps: This creates a cycle (30 x) for these program steps.
  - X: Deletes the program step.

4. Wait for the start window to close.

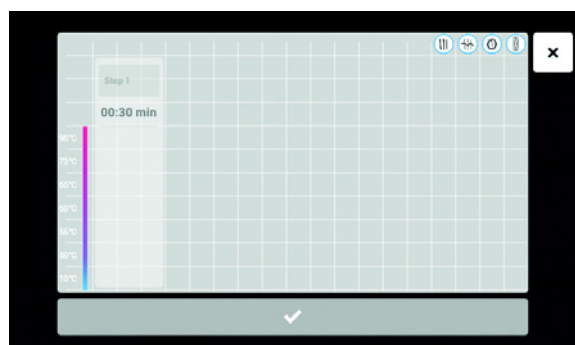
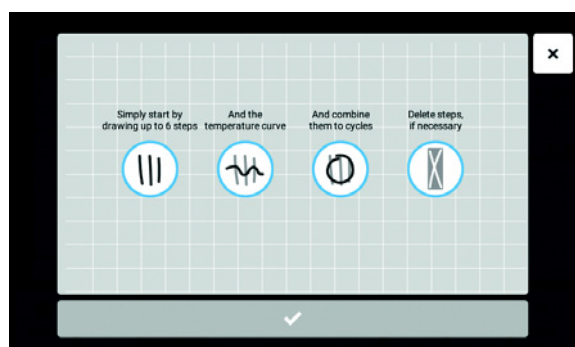

5. Create the program steps, temperatures and cycles.
6. Confirm the program steps.  
 The *Sketch mode* window is closed.
7. Tap the *Save* button.  
 The changed program is saved.

### 7.7.4 Setting gradients

A gradient step can be used to optimize the specificity and yield in PCR reactions. A vertically or horizontally increasing temperature gradient is generated during the holding time. The ramp rates before and after the gradient step are constant across the entire thermoblock.



The gradient function is only available if the *Block Settings* were selected correctly (see p. 56). If *Any* is set, no gradient temperatures are displayed. The gradient temperature can be set between 30 °C and 99 °C. If a gradient temperature below 30 °C was defined, an alarm message is displayed when the program starts. The gradient spread is 30 °C max.

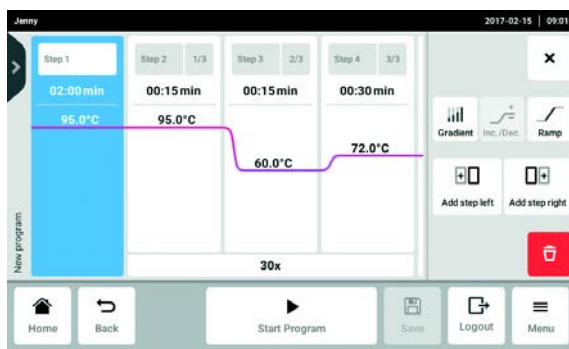

1. Select the column with the program step that is to be edited.

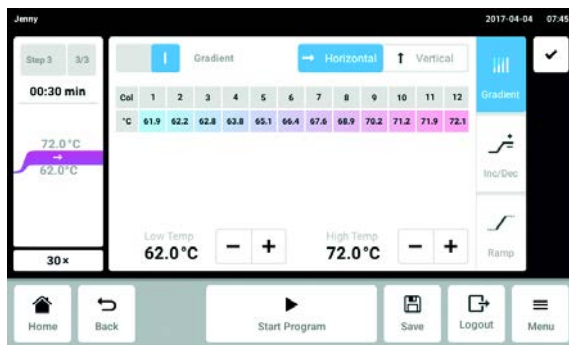

2. Tap the *Gradient* button and enable the function.
3. Select a horizontal or vertical gradient function.
4. Define the low temperature *Low Temp* and high temperature *High Temp*.
5. Tap the *Save* button.  
The changed program is saved.
6. Close the window.

## 7.7.5 Defining increments and decrements



1. Select the column with the program step that is to be edited.

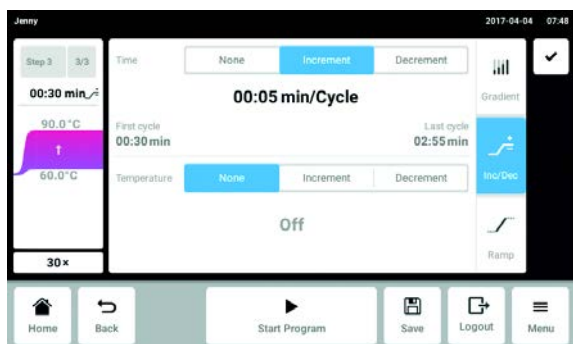

2. Enter the increment or decrement for the cycle time.  
*Time:* The duration of the next cycle will be increased or reduced by the set value.  
 Adjustable from 00:01 to 01:00 in 1 s increments.

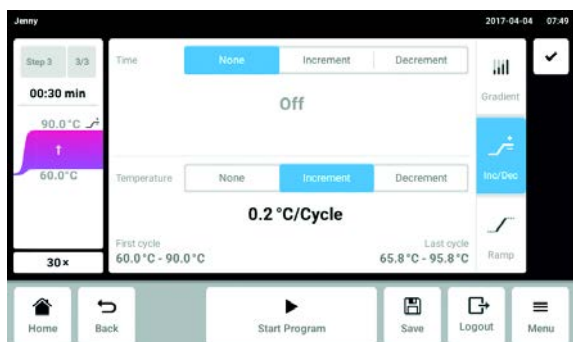

3. Enter the increment or decrement for the block temperature.  
*Temperature:* The block temperature will be increased or reduced by the set value for the next cycle.  
 Adjustable within the block limits of 4 °C and 99.0 °C, in increments of 0.1 °C.
4. Close the window.
5. Tap the *Save* button.  
 The changed program is saved.

## 7.7.6 Defining the ramp

The ramp can be used to set the temperature control speed of the thermoblock in increments.

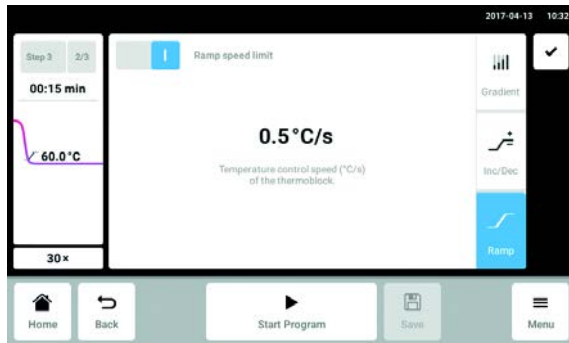

1. Select the column with the program step that is to be edited.
2. Tap the *Ramp* button and enable the function.
3. Enter the value for the ramp rate (cooling).  
 The maximum ramp rate depends on the cooling rate (see *Application parameters on p. 96*).
4. Close the window.
5. Tap the *Save* button.  
 The changed program is saved.

## 7.7.7 Deleting a program step



1. Select the column with the program step that is to be deleted.
2. Tap the *Delete* button.  
 The program step is deleted.





**8 PCR run**  
**8.1 Loading the thermoblock**  
**8.1.1 Selecting the sample tubes**



**WARNING! Biohazard due to unsuitable reaction vessels, plates and lids.**  
 Unsuitable reaction vessels, plates and lids will get damaged in the Cycler. This will release sample material.

- ▶ Only use reaction vessels, plates and lids that meet the requirements specified in the operating manual.

**Approved sample tubes for devices with a thermoblock with 96 wells**

The thermoblock can be loaded with the following sample tubes:

- 0.1 mL PCR strips
- 0.2 mL PCR tubes and PCR strips
- 96-well PCR plates

**Approved sample tubes for devices with a thermoblock with 384 wells**

The thermoblock can be loaded with the following sample tubes:

- 384-well PCR plates

**Compatible types of PCR plates**

The following types of PCR plates are compatible.

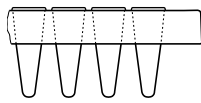
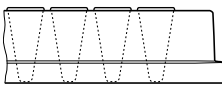
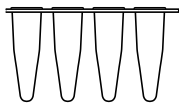
Semi-skirted PCR plate	Skirted PCR plate	Non-skirted/unskirted PCR plate
		
PCR plate with a semi skirt.	PCR plate with full skirt.	PCR plate without a skirt.

**Requirements for sample tubes**

The sample tubes must meet the following requirements:

- Temperature resistance of 110 °C min.
- Accurate fit in the thermoblock

## Maximum volumes

The sample volumes may vary depending on which type of sample tube is used.

### For devices with a thermoblock with 96 wells

- PCR plates: Max. 100 µL
- 0.1 mL PCR strips: Max. 100 µL
- 0.2 mL PCR tubes and PCR strips: Max. 100 µL

### For devices with a thermoblock with 384 wells

- PCR plates: Max. 25 µL

## 8.1.2 Inserting the sample tubes

---



### **WARNING! Biohazard due to sample material directly in the thermoblock.**

- ▶ Do not fill sample material directly into the thermoblock.
- ▶ Only use reaction vessels, plates and lids that meet the requirements specified in the operating manual.



### **WARNING! Biohazard when tempering with the heated lid open.**

When tempering with an open heated lid, the lids of the reaction vessels can spring open. This will release sample material.

- ▶ Only temper with a closed heated lid.
- 

Observe the following notes:

- ▶ Never run programs with an empty thermoblock. Always load the thermoblock with PCR plates or PCR tubes for a program run.
- ▶ Place the tubes in the center of the thermoblock and ensure that they are positioned symmetrically towards the center.
- ▶ Load the thermoblock with a minimum of 5 tubes. If you have fewer reaction batches, add some empty tubes to ensure that the thermoblock is loaded with a minimum of 5 tubes.



Very soft PCR tubes may become deformed at high temperatures. To prevent deformation:

- Increase the number of empty sample tubes in the thermoblock.
- Reduce the temperature of the heated lid.
- Use original Eppendorf PCR consumables. Eppendorf PCR consumables are a perfect match for the device.

## 8.2 Selecting a program

### 8.2.1 Selecting a program in the *Program Manager*

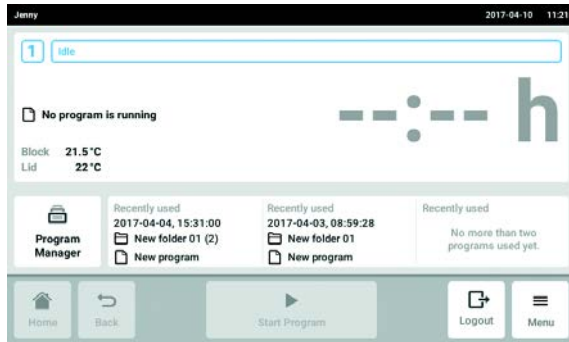

- ▶ Tap the *Program Manager* on the home screen. The window with the *Program Manager* is displayed.



The available folders with programs are displayed depending on the user rights.

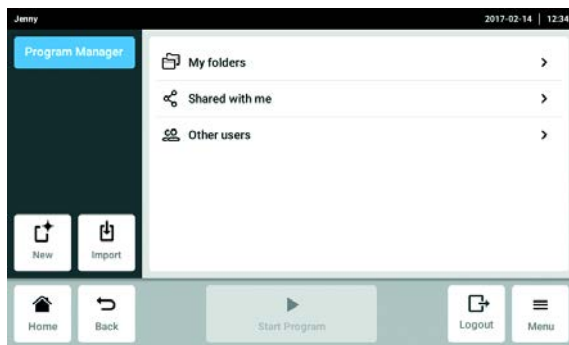

- ▶ Open the *My folders* folder. Your own folders are displayed.

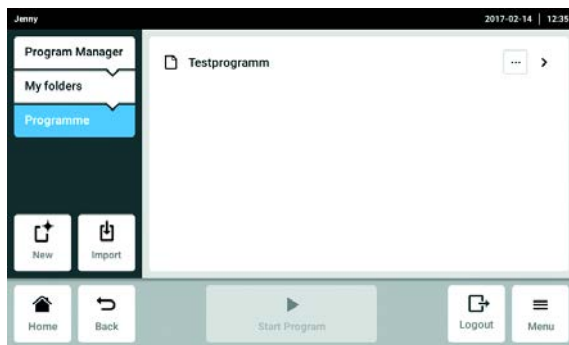

- ▶ Open one of your own folders. Your own available programs are displayed.
- ▶ Select a program. The program window is displayed.

## 8.2.2 Selecting the most recently used program

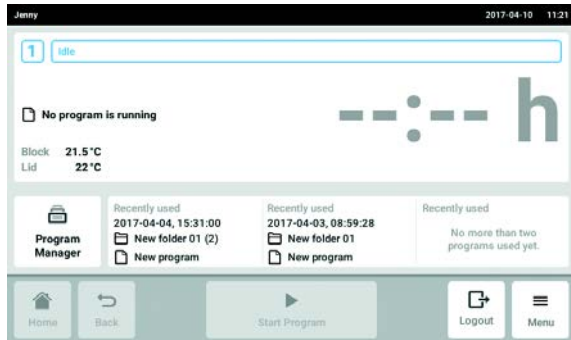

- ▶ Select a program under *Recently used* on the home screen.  
The program window is displayed.

## 8.3 Starting a program



The *Start Program* button is inactive on the home screen. The button is only active in the program window if a program has been selected.  
 A wrong program can result in sample loss. Before a program is started:

- ▶ Check the program selection.

### Prerequisites

- The thermoblock is loaded
- Heated lid is closed

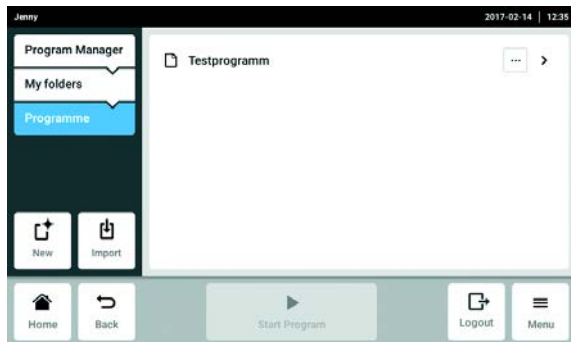

1. Select the program using the *Program Manager* or from the most recently used programs on the home screen.  
The program window is displayed and the *Start Program* button is now active.



2. Tap the *Start Program* button.

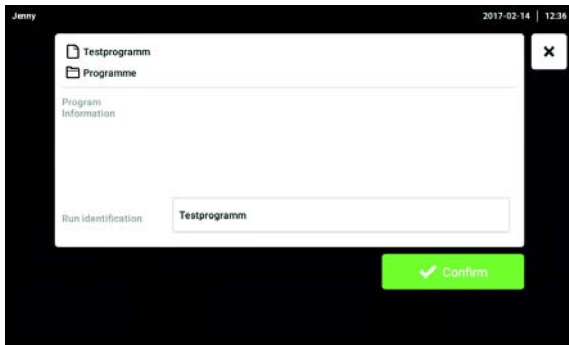

3. Accept or change the *Run identification* edit box.

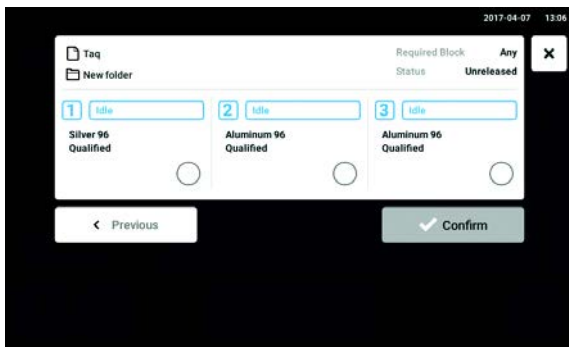

4. Select the Cyclers (only if eco devices are connected).

5. Confirm the program selection.  
 The program starts.

### 8.4 Pausing and resuming a program

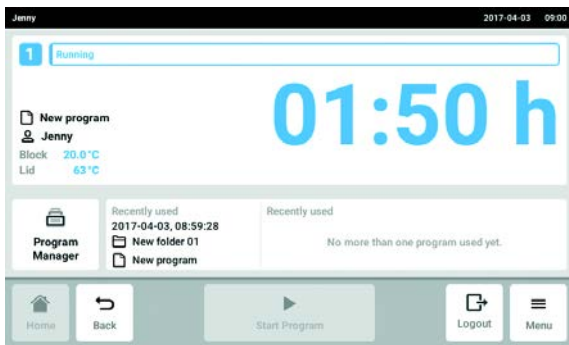

1. On the home screen, tap the window with the information about the current program.  
 The program window is displayed.

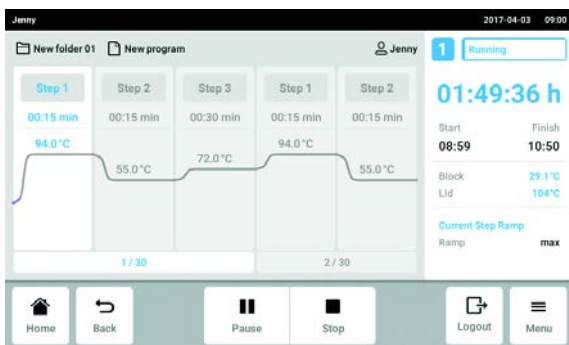

2. Tap the *Pause* button.  
 The program is paused.

## PCR run Mastercycler® X50 English (EN)

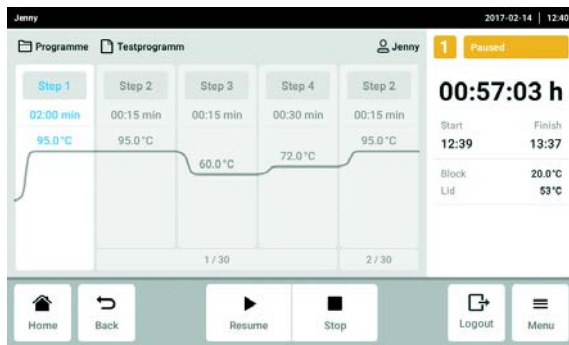

- Tap the *Resume* button.  
The program is resumed.

## 8.5 Display the remaining run time for the program

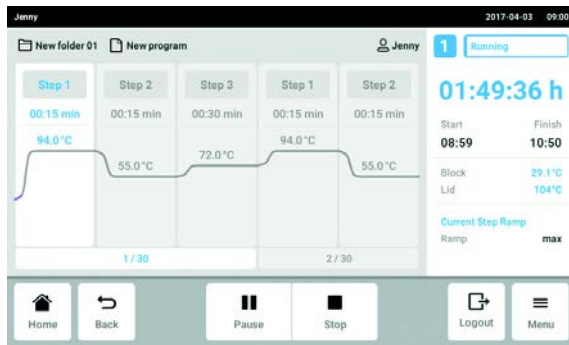

- ▶ Tap the display with the remaining run time.  
A window with the remaining run time opens.

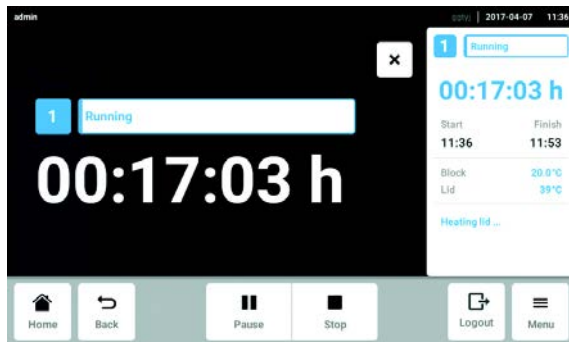

## 8.6 Aborting the program

1. On the home screen, tap the window with the information about the current program. The program window is displayed.

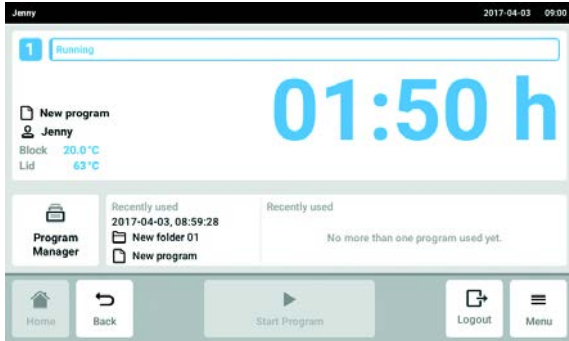

2. Tap the *Stop* button.

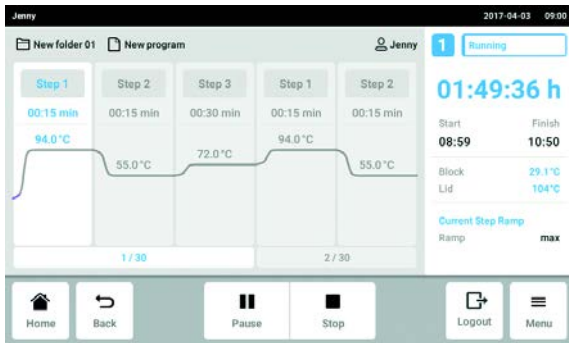

3. Tap the *Abort Program* button. The program is shut down.

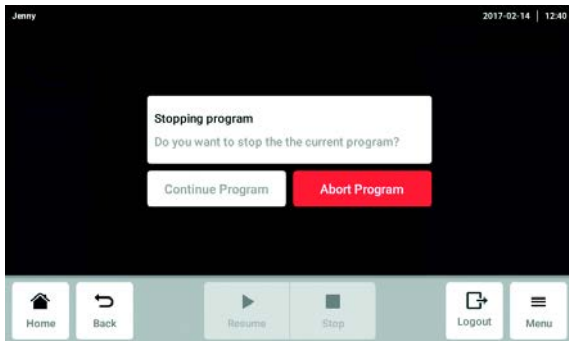





## 9 Settings

### 9.1 Accessing settings

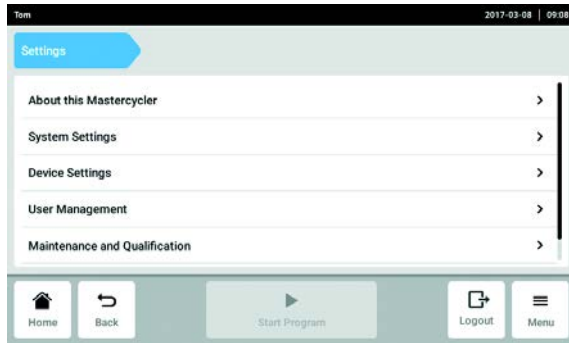

1. Tap the *Menu* button.
2. Tap the *Settings* button.  
 The following menu items are displayed:
  - *About this Mastercycler* (see *About this Mastercycler* on p. 77)
  - *System Settings* (see *System Settings* on p. 77)
  - *Device Settings* (see *Device Settings* on p. 81)
  - *User Management* (see *Editing the user administration* on p. 45)
  - *Maintenance & Qualification* (see *Setting service and maintenance intervals* on p. 83)

### 9.2 About this Mastercycler

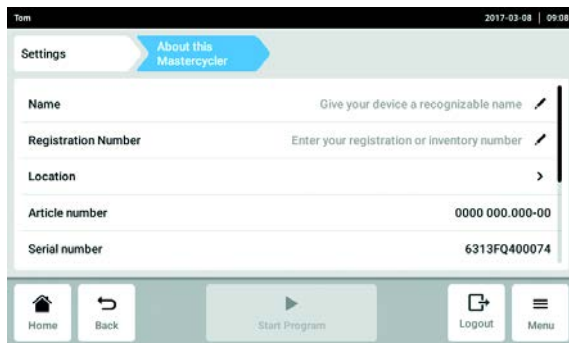

- ▶ Tap the *About this Mastercycler* button.  
 The following information can be accessed:
  - *Name*: The device name can be entered by the administrator.  
 If no name is entered, the device will be referred to as *Unknown Device* in the export files.
  - *Registration Number*: The registration number can be entered by the administrator.
  - *Location*: Location information can be entered by the administrator.
  - *Article number*
  - *Serial number*
  - *Software Version*
  - *Hardware Configuration*
  - *Associated Devices*
  - *License Information*

### 9.3 System Settings

#### 9.3.1 Accessing System Settings

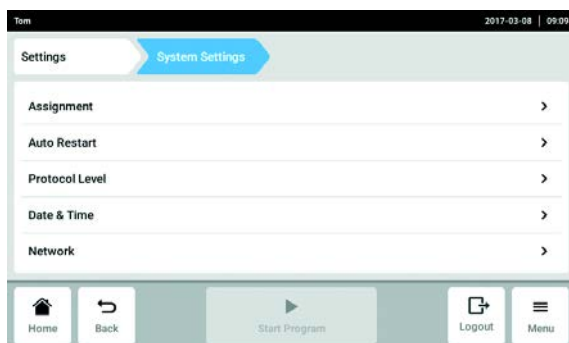

- ▶ Tap the *System Settings* button.  
 The following settings can be made.
  - *Assignment*: Assign eco devices.
  - *Auto Restart*
  - *Protocol Level*
  - *Date & Time*: Set the date, time and time zone.
  - *Network*: Set the parameters for network operation.

### 9.3.2 Assignment

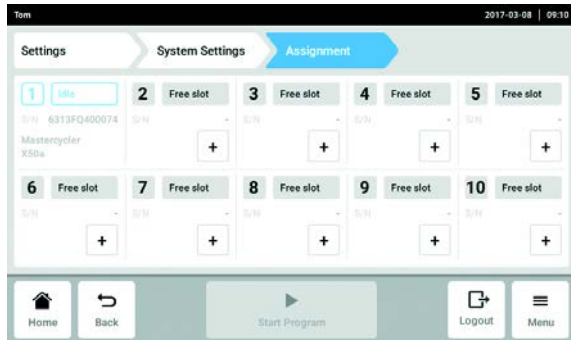

1. Tap the *Assignment* button.
2. Select a free slot.  
All the eco devices that are connected or available on the Intranet are displayed in a selection list.
3. Assign the eco device to the slot.
4. Enter and confirm the *Registration ID* of the eco device.  
The eco device can be operated via the Master device.



The *Registration ID* is shown on the display of the eco device.

### 9.3.3 Auto Restart

If the *Auto Restart* function is enabled, the program that is currently running is resumed automatically after a mains/power outage.

The *Restart Time* parameter defines how long a mains/power outage can last. The current program is not resumed if the mains/power supply to the device is restored after this time has elapsed.

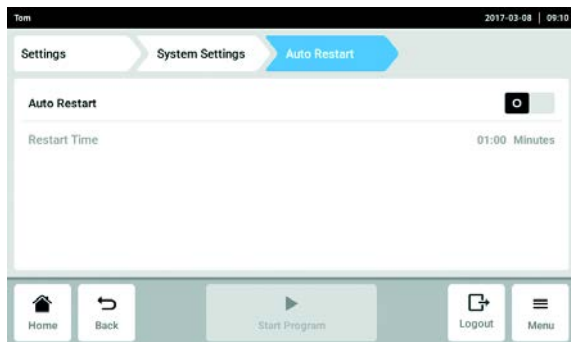

1. Tap the *Auto Restart* button.
2. Use the *Auto Restart* switch to enable the function.
3. Tap the *Restart Time* button.
4. Enter the value for the *Restart Time* parameter.  
Permitted values: 1 s – 45 h

### 9.3.4 Protocol Level

The function *Export detailed program run protocol* defines how logs are exported. If the function is enabled, more detailed logs are exported.

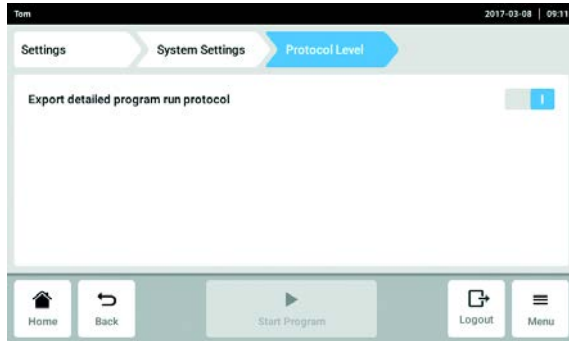

1. Tap the *Protocol Level* button.
2. Use the switch to enable or disable the function *Export detailed program run protocol*.

### 9.3.5 Date & Time



Do not set the date and time while the program is running.



If the date, time or time zone are changed, logs may be sorted incorrectly.

#### Setting the date and time automatically

##### Prerequisites

- The device is connected to the network. A time server is available.

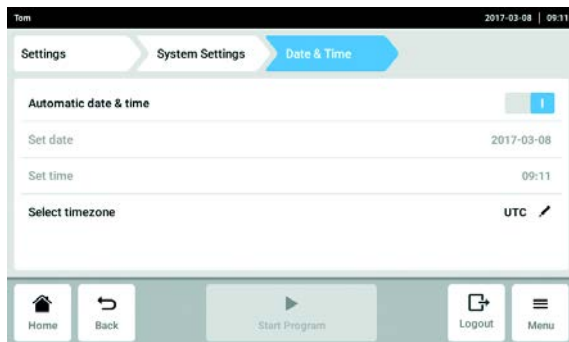

1. Tap the *Date & Time* button.
2. Use the *Automatic date & time* switch to enable the function.
3. Tap the *Select timezone* button.
4. Select the continent and the time zone.

### Setting the date and time manually

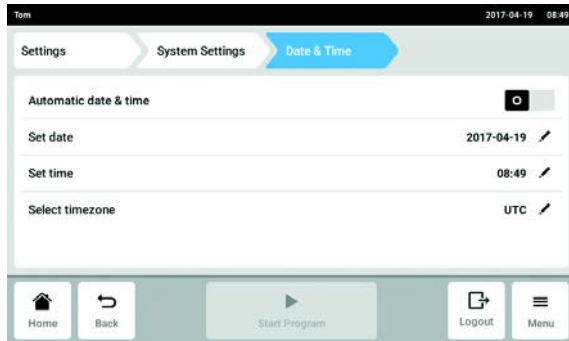

1. Tap the *Date & Time* button.
2. Use the *Automatic date & time* switch to disable the function.  
*Set date* and *Set time* can be selected.
3. Tap the *Set date* button and enter the date.
4. Tap the *Set time* button and enter the time.
5. Tap the *Select timezone* button.
6. Select the continent and the time zone.

### 9.3.6 Network



The master device can be connected directly to the Internet and an internal network. An Internet connection is not required for operation. If the master device is connected to the Internet, the owner is responsible for data security.

- ▶ A connection to the internal network or the Internet may only be established by a network administrator.
- ▶ Check the settings for the internal network or the Internet before establishing a connection.

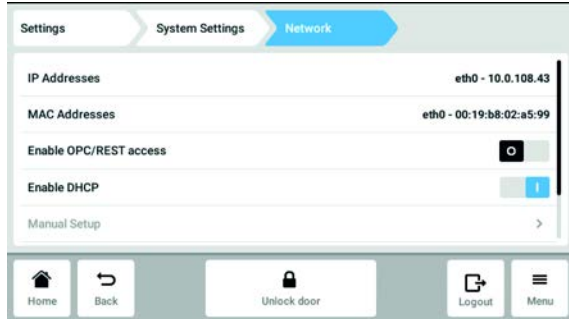

1. Tap the *Network* button.  
The following settings can be made.
  - *IP Adresses*: Current IP address of the device.
  - *MAC Adresses*: Number which uniquely identifies the device in the network.
  - *Enable OPC/REST access*: The device allows communication with an external software via OPC or REST.
  - *Enable DHCP*: The device uses an IP address which was assigned to it by an existing DHCP server.
  - *Manual Setup*: Enables a window. This window can be used to enter the network settings manually if no DHCP server is available. Manual Setup can only be selected if automatic IP address assignment (Enable DHCP) is disabled.

## Manual Setup

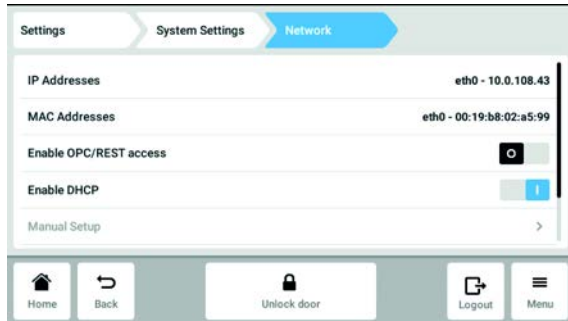

2. Use the switch to disable the *Enable DHCP* function.  
*Manual Setup* can be selected.
3. Tap the *Manual Setup* button.
4. Complete the entries in the input window and confirm.

## 9.4 Device Settings

### 9.4.1 Accessing Device Settings

- ▶ Tap the *Device Settings* button.  
 The following settings can be made.
  - *Acoustic Signals*: Setting the volume and the acoustic alarm.
  - *Display Settings*: Setting the brightness and power saving mode.

### 9.4.2 Acoustic Signals

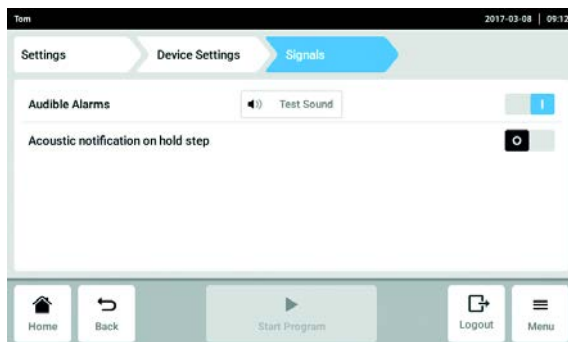

1. Tap the *Acoustic Signals* button.
2. Enable or disable the acoustic alarm.
3. Enable or disable *Acoustic notification on hold step*.

### 9.4.3 *Display Settings*

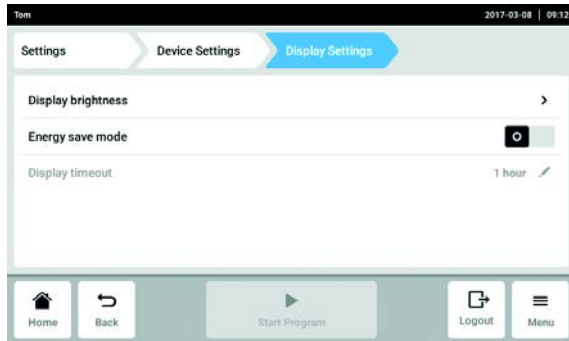

1. Tap the *Display Settings* button.

#### **Setting the brightness**

2. Tap the *Display brightness* button.  
The slider control bar for the brightness setting is displayed.

3. Set the brightness.

#### **Enabling the power saving mode**

4. Use the *Energy save mode* switch to enable or disable the power saving mode.

#### **Setting the *Display timeout***

##### Prerequisites

Power saving mode has been enabled.

5. Tap the *Display timeout* button.  
A window with specified times is displayed.
6. Select the time after which the brightness of the display is dimmed.  
The brightness of the display is dimmed if there is no input during the selected interval.

## 9.5 Setting service and maintenance intervals

### 9.5.1 Accessing *Maintenance & Qualification*



Information on the service procedure:

- *Self Test* (see p. 39)
- *Verification* (see p. 38)

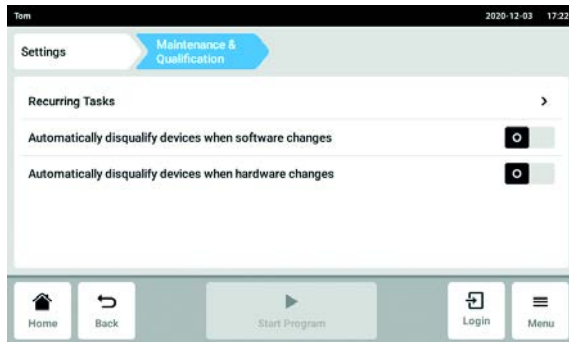

- ▶ Tap the *Maintenance & Qualification* button. The following settings can be made.
  - *Recurring Tasks*: Editing recurring tasks
  - Enable or disable *Automatically disqualify devices when software changes*
  - Enable or disable *Automatically disqualify devices when hardware changes*

### 9.5.2 Editing recurring tasks

The *Self Test* and *Verification* tasks can be edited.

The setting *Warn & Disqualify* under *Task Policy* has special consequences. If *Warn & Disqualify* is selected the device disqualifies itself automatically as soon as the task exceeds the value that was defined for when it becomes due. If this occurs the device changes to *Disqualified*. If the device is to be requalified, the settings must be changed in *Task Policy*.

#### *Self Test*

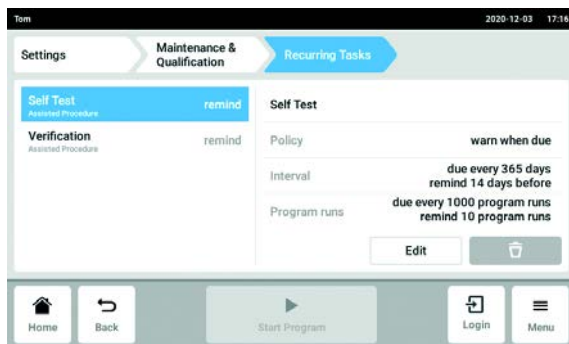

1. Tap *Self Test*.
2. Tap the *Edit* button.
3. Select the option for *Task Policy* and tap *Continue* to confirm.
 

If *Warn & Disqualify* was selected, read the message and agree with the content by tapping the *Confirm* button or close the message and select a different option.
4. Select the option for *Task Trigger* and tap *Continue* to confirm.
5. Enter values for the selected option and adopt the settings by tapping *Finish*.
6. Tap *Verification*.
7. Tap the *Edit* button.

### Verification

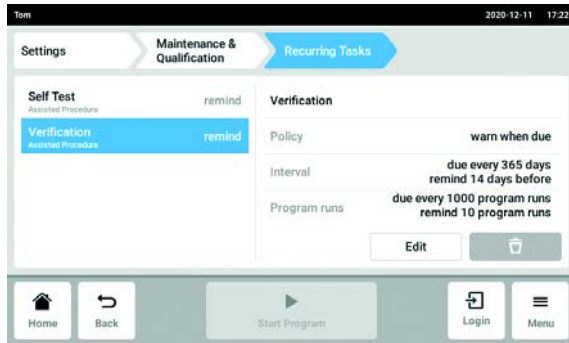

8. Tap *Verification*.
9. Tap the *Edit* button.
10. Select the option for *Task Policy* and tap *Continue* to confirm.  
 If *Warn & Disqualify* was selected, read the message and agree with the content by tapping the *Confirm* button or close the message and select a different option.
11. Select the option for *Task Trigger* and tap *Continue* to confirm.
12. Enter values for the selected option and adopt the settings by tapping *Finish*.



## 10 Maintenance

### 10.1 Performing a software update

The software update is performed on the master device. The software update on all eco devices is performed afterwards.

#### Checking the software version on the device

1. Check which software version is installed on the device. Tap the menu path *Menu > Settings > About this Mastercycler*.

The software version is displayed under *Software Version*.

#### Requesting a software update

2. Request the data for the software update from your local Eppendorf partner. The address can be found on the Internet at [www.eppendorf.com](http://www.eppendorf.com).
3. Save the **update.zip** file with the software update on a USB stick.
4. Unzip the **update.zip** file.



- The device has only access to the data at the top level of the USB stick.
- Do not save the data in a folder.

#### Performing a software update

##### Prerequisites

- The Master device is switched off.
- All eco devices on which the software is to be updated are connected and have been switched on. All eco devices must be in the idle state. There must not be any programs running.



If the function *Menu > Settings > Maintenance & Qualification > Automatically disqualify devices when software changes* is enabled the device needs to be requalified after the software update.

5. Connect the USB stick with the software update to the device.
6. Switch on the master device.

The Mastercycler is started from the USB stick.

7. Follow the instructions on the device until the software update is complete.



Do not abort the software update. If the update is stopped, this will result in loss of data and the device will have to be reset to the factory settings. If this happens contact the authorized service.



All the eco devices that are connected are updated automatically if a software update is available for the eco devices.

## 10.2 Cleaning



### NOTICE! Damage from the use of aggressive chemicals.

- ▶ Do not use any aggressive chemicals on the device or its accessories, such as strong and weak bases, strong acids, acetone, formaldehyde, halogenated hydrocarbons or phenol.
- ▶ If the device has been contaminated by aggressive chemicals, clean it immediately using a mild cleaning agent.

### 10.2.1 Cleaning the touch screen

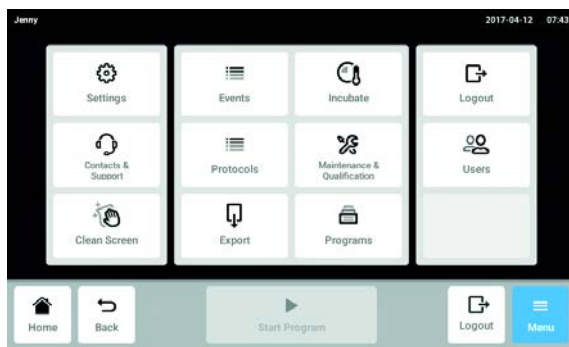

1. Tap the *Menu > Clean Screen* button.  
 The touch screen is locked and can be cleaned.

#### Unlocking the locked touch screen

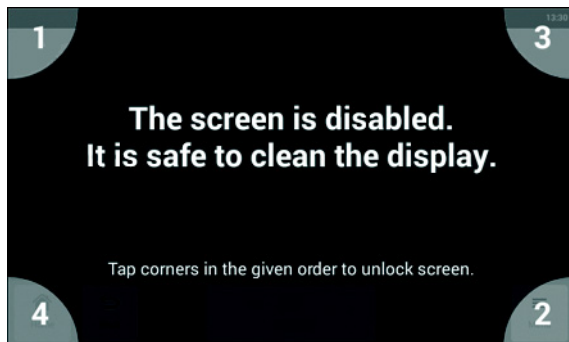

2. Tap the corners in the numbered sequence.  
 The touch screen is unlocked and the previous screen is displayed.

## 10.2.2 Cleaning the housing

---



**DANGER! Electric shock due to the ingress of liquid.**

- ▶ Switch off the device and disconnect it from the mains/power line before commencing any cleaning or disinfection procedures.
- ▶ Do not allow any liquids to penetrate the inside of the housing.
- ▶ Do not spray clean or spray disinfect the housing.
- ▶ Only reconnect the device to the mains/power line when it is completely dry, both inside and outside.



**DANGER! Electric shock.**

- ▶ Switch off the device and disconnect the mains/power plug before commencing any service or cleaning procedures.
- 

- ▶ Use a damp, lint-free cloth to clean the surface of the Mastercycler X50.
- ▶ Use a neutral laboratory cleaner, if required.

Instructions for disinfection and decontamination of the device are described separately.

### 10.2.3 Cleaning the heated lid and thermoblock

---



**CAUTION! Risk of burns on the thermoblock, heated lid and reaction vessels.**

The thermoblock, heated lid and reaction vessels reach temperatures of over 50 °C very quickly.

- ▶ Wait until the temperature of the thermoblock, heated lid and reaction vessels is below 30 °C.
  - ▶ Then open the heated lid.
- 



**DANGER! Electric shock due to the ingress of liquid.**

- ▶ Switch off the device and disconnect it from the mains/power line before commencing any cleaning or disinfection procedures.
  - ▶ Do not allow any liquids to penetrate the inside of the housing.
  - ▶ Do not spray clean or spray disinfect the housing.
  - ▶ Only reconnect the device to the mains/power line when it is completely dry, both inside and outside.
- 



**DANGER! Electric shock.**

- ▶ Switch off the device and disconnect the mains/power plug before commencing any service or cleaning procedures.
- 

1. Open the heated lid.
2. Remove any contamination on the block and on the bottom of the heated lid. Use a damp, lint-free cloth for this purpose. Use a neutral laboratory cleaner, if required.
3. Check whether there is any labeling residue from tube lids on the heated lid. Use ethanol or isopropanol to remove any residue.



- Keep the bores of the block free from dust and lint.  
Even small deposits will affect the heat transfer between the thermoblock and the vessels.

### 10.3 Disinfection/decontamination

---



**NOTICE! Damage from UV and other high-energy radiation.**

- ▶ Do not use UV, beta or gamma rays or any other high-energy forms of radiation for disinfection.
  - ▶ Avoid storage in areas with high UV radiation levels.
- 

#### Required equipment

- Alcohol (70%) (ethanol, isopropanol) or disinfectants containing alcohol

Proceed as follows:

1. Choose the disinfection method which corresponds to the legal regulations and guidelines in place for your range of application.
2. Switch off the device and disconnect it from the mains/power line.
3. Allow the device to cool down.
4. Wipe all parts of the device and accessories using the disinfectant.

### 10.4 Decontamination before shipment

If you are shipping the device to the authorized Technical Service for repairs or to your authorized dealer for disposal please note the following:



**WARNING! Risk to health from contaminated device.**

1. Observe the information in the decontamination certificate. It is available as a PDF document on our webpage (<https://www.eppendorf.com/decontamination>).
  2. Decontaminate all parts to be shipped.
  3. Include the fully completed decontamination certificate in the package.
-



## 11 Troubleshooting

### 11.1 General errors

Technical faults may be triggered by faults such as a power failure or power fluctuations.

In most cases, the following procedure is therefore sufficient:

1. Switch the device briefly off and back on again after about 10 seconds.
2. Check cable connections.
3. If the fault occurs again: Notify your Eppendorf service team.

#### 11.1.1 *Contacts & Support*

This area is used to enter contact information and access device information for the communication with the authorized service to support the troubleshooting process.

##### 11.1.1.1 Adding a contact

1. Navigate to *Contacts & Support* via *Menu*.
2. Tap the *Contacts* button.
3. Tap the *Add Contact* button.
4. Enter the name and confirm the entry.
5. Enter more contact information and confirm each entry.



If you would like to add your local Eppendorf partner as a contact you can find this information at [www.eppendorf.com](http://www.eppendorf.com).

##### 11.1.1.2 Accessing device information

1. Navigate to *Contacts & Support* via *Menu*.
2. Tap the *Diagnostics* button.
3. Tap the *Service Information* button.
4. Forward the device information to the authorized service technician.





## 12 Transport, storage and disposal

### 12.1 Packing



**CAUTION! Risk of injury due to lifting and carrying heavy loads**

The device is heavy. Lifting and carrying the device can lead to back injuries.

- ▶ Only transport and lift the device with an adequate number of helpers.
- ▶ Use a transport aid to transport the device.



**NOTICE! Risk of damage due to incorrect packing.**

Eppendorf SE is not liable for any damage caused by improper packing.

- ▶ Only store and transport the device in its original packing.



**WARNING! Risk to health due to contaminated device and accessories.**

- ▶ Decontaminate the device and accessories prior to storage or shipping.

Use the supplied packing material when packing the device for transport or storage. If you do not have this anymore or if it is damaged, contact your Eppendorf office.

Prepare the device as follows prior to packing:

1. Pay attention to the decontamination notes (see *Decontamination before shipment on p. 89*).
2. Let the device stand for 30 minutes and make sure there is no condensate in the thermoblock.
3. Load the thermoblock with an empty PCR plate.
4. Close the heated lid.

### 12.2 Transport

- ▶ Use the original packaging and the transport securing devices for transport.

	Air temperature	Relative humidity	Atmospheric pressure
General transport	-25 °C – 60 °C	10 % – 95 %	30 kPa – 106 kPa
Air freight	-40 °C – 55 °C	10 % – 95 %	30 kPa – 106 kPa

## 12.3 Disposal

Observe the relevant legal regulations when disposing of the product.

### **Information on the disposal of electrical and electronic devices in the European Community:**

Within the European Community, the disposal of electrical devices is regulated by national regulations based on EU Directive 2012/19/EU pertaining to waste electrical and electronic equipment (WEEE).

According to these regulations, any devices supplied after August 13, 2005, in the business-to-business sphere, to which this product is assigned, may no longer be disposed of in municipal or domestic waste. They are marked with the following symbol to indicate this:

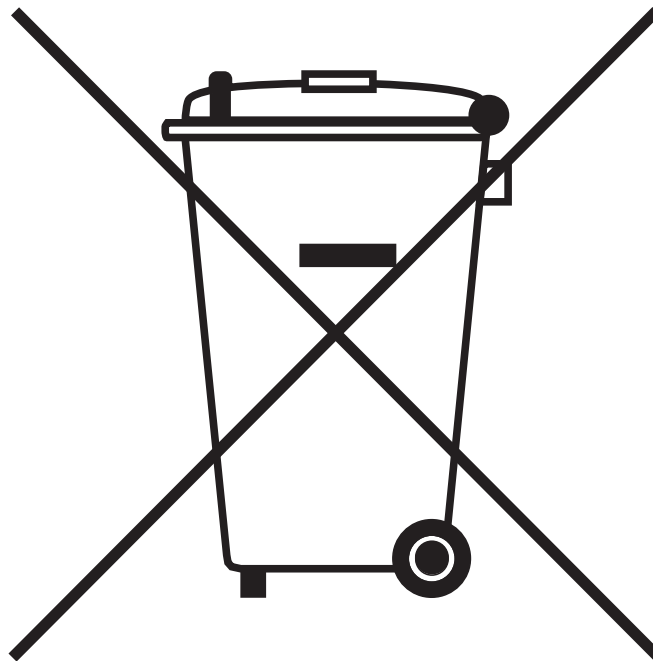

As the disposal regulations may differ from one country to another within the EU, please contact your supplier for more information.

## 13 Technical data

### 13.1 Power supply

Voltage	100 V – 240 V, $\pm 10$ %
Frequency	50 Hz – 60 Hz
Power consumption (devices with aluminum thermoblock)	max. 850 W
Power consumption (devices with silver thermoblock)	max. 850 W
EMC: noise emission (radio interference)	IEC/DIN EN 55011 Class B - residential area
EMC: noise immunity	IEC/EN 61326-1
Overvoltage category	II (IEC 61010-1)
Degree of pollution	2
Protection class	I

### 13.2 Weight/dimensions

Dimensions	Width: 27.5 cm Depth: 43 cm Height: 33 cm Height with heated lid open: 43.9 cm
Weight (Master variant)	11.5 kg
Weight (eco variant)	10.7 kg

### 13.3 Ambient conditions

General operation	15 °C – 35 °C up to 75 % relative humidity up to 2 000 m NN (approx. 80 kPa)
Storage	-20 °C – 70°C up to 95 % relative humidity

### 13.4 Application parameters

<b>Mastercycler X50a, Mastercycler X50I</b>	
Thermoblock	Aluminum 96 wells
Sample capacity	<ul style="list-style-type: none"> <li>• 96 × 0.1 mL PCR tubes</li> <li>• 96 × 0.2 mL PCR tubes</li> <li>• one 96-well PCR plate (unskirted, semi-skirted, skirted and low-profile)</li> </ul>
Thermoblock temperature control range	4 °C – 99 °C
Ramp rate (heating) (measured on the thermoblock)	max. 5°C/s
Ramp rate (cooling) (measured on the thermoblock)	max. 2.3 °C/s
Thermoblock temperature homogeneity (with the gradient function switched off) at 20 – 72 °C at 72 – 95 °C	±0.2 °C ±0.3 °C
Control accuracy (with the gradient function switched off)	±0.15 °C
Gradient spread (horizontal and vertical)	max. 30°C
Gradient temperature control range (horizontal and vertical)	30 °C – 99 °C
Heated lid temperature control range	37 °C – 110 °C

<b>Mastercycler X50h, Mastercycler X50t</b>	
Thermoblock	Aluminum 384 wells
Sample capacity	• one 384-well PCR plate
Thermoblock temperature control range	4 °C – 99 °C
Ramp rate (heating) (measured on the thermoblock)	max. 5°C/s
Ramp rate (cooling) (measured on the thermoblock)	max. 2.3 °C/s
Thermoblock temperature homogeneity (with the gradient function switched off) at 20 – 72 °C at 72 – 95 °C	±0.2 °C ±0.3 °C
Control accuracy (with the gradient function switched off)	±0.15 °C
Gradient spread (horizontal and vertical)	max. 30°C
Gradient temperature control range (horizontal and vertical)	30 °C – 99 °C
Heated lid temperature control range	37 °C – 110 °C

<b>Mastercycler X50s, Mastercycler X50i</b>	
Thermoblock	Silver 96 wells
Sample capacity	<ul style="list-style-type: none"> <li>• 96 × 0.1 mL PCR tubes</li> <li>• 96 × 0.2 mL PCR tubes</li> <li>• one 96-well PCR plate (unskirted, semi-skirted, skirted and low-profile)</li> </ul>
Thermoblock temperature control range	4 °C – 99 °C
Ramp rate (heating) (measured on the thermoblock)	max. 10°C/s
Ramp rate (cooling) (measured on the thermoblock)	max. 5°C/s
Thermoblock temperature homogeneity (with the gradient function switched off) at 20 – 72 °C at 72 – 95 °C	±0.2 °C ±0.3 °C
Control accuracy (with the gradient function switched off)	±0.15 °C
Gradient spread (horizontal and vertical)	max. 30°C
Gradient temperature control range (horizontal and vertical)	30 °C – 99 °C
Heated lid temperature control range	37 °C – 110 °C



# Declaration of Conformity

The product named below fulfills the requirements of directives and standards listed. In the case of unauthorized modifications to the product or an unintended use this declaration becomes invalid. This declaration of conformity is issued under the sole responsibility of the manufacturer.

**Product name:**

Mastercycler® X50i (6301)	Mastercycler® X50l (6303)	Mastercycler® X50r (6305)
Mastercycler® X50t (6306)	Mastercycler® X50s (6311)	Mastercycler® X50a (6313)
Mastercycler® X50p (6315)	Mastercycler® X50h (6316)	

**Product type:**

Thermocycler

**Relevant directives / standards:**

2014/35/EU:	EN 61010-1, EN 61010-2-010 UL 61010-1, CAN/CSA C22.2 No. 61010-1
2014/30/EU:	EN 61326-1, EN 55011
2011/65/EU:	EN 50581 EN ISO 14971 47 CFR FCC part 15

Hamburg, June 27, 2017



Dr. Wilhelm Plüster  
Management Board



Dr. Philip Müller  
Portfolio Management

Your local distributor: [www.eppendorf.com/contact](http://www.eppendorf.com/contact)  
Eppendorf AG · Barkhausenweg 1 · 22339 Hamburg · Germany  
[eppendorf@eppendorf.com](mailto:eppendorf@eppendorf.com)

Eppendorf®, the Eppendorf Brand Design and Mastercycler® are registered trademarks of Eppendorf AG, Germany.  
All rights reserved, incl. graphics and pictures. Copyright ©2017 by Eppendorf AG.

[www.eppendorf.com](http://www.eppendorf.com)

ISO  
9001  
Certified

ISO  
13485  
Certified

ISO  
14001  
Certified

6313 900.990-01







# Evaluate Your Manual

Give us your feedback.

[www.eppendorf.com/manualfeedback](http://www.eppendorf.com/manualfeedback)

**Your local distributor: [www.eppendorf.com/contact](http://www.eppendorf.com/contact)**

Eppendorf SE · Barkhausenweg 1 · 22339 Hamburg · Germany  
[eppendorf@eppendorf.com](mailto:eppendorf@eppendorf.com) · [www.eppendorf.com](http://www.eppendorf.com)